

***PROFESSIONAL***

Model PMD570 User Guide

---

Solid State Recorder

**marantz®**

## Warnings and Cautions

	<b>CAUTION</b> RISK OF ELECTRIC SHOCK DO NOT OPEN	
<p>CAUTION: TO REDUCE THE RISK OF ELECTRIC SHOCK, DO NOT REMOVE COVER (OR BACK) NO USER-SERVICEABLE PARTS INSIDE REFER SERVICING TO QUALIFIED SERVICE PERSONNEL</p>		

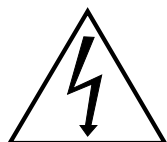

The lightning flash with arrowhead symbol within an equilateral triangle is intended to alert the user to the presence of uninsulated "dangerous voltage" within the product's enclosure that may be of sufficient magnitude to constitute a risk of electric shock to persons.



The exclamation point within an equilateral triangle is intended to alert the user to the presence of important operating and maintenance (servicing) instructions in the literature accompanying the product.

## WARNING

**TO REDUCE THE RISK OF FIRE OR ELECTRIC SHOCK,  
DO NOT EXPOSE THIS APPLIANCE TO RAIN OR MOISTURE.**

---

**CAUTION: USE OF CONTROLS OR ADJUSTMENTS OR  
PERFORMANCE OF PROCEDURES OTHER  
THAN THOSE SPECIFIED HEREIN MAY  
RESULT IN HAZARDOUS RADIATION  
EXPOSURE.**

---

# Important Safety Instructions

## READ BEFORE OPERATING EQUIPMENT

This product was designed and manufactured to meet strict quality and safety standards. There are, however, some installation and operation precautions which you should be particularly aware of.

1. Read Instructions – All the safety and operating instructions should be read before the product is operated.
2. Retain Instructions – The safety and operating instructions should be retained for future reference.
3. Heed Warnings – All warnings on the product and in the operating instructions should be adhered to.
4. Follow Instructions – All operating and use instructions should be followed.
5. Cleaning – Unplug this product from the wall outlet before cleaning. Do not use liquid or aerosol cleaners. Use a damp cloth for cleaning.
6. Attachments – Do not use attachments not recommended by the product manufacturer as they may cause hazards.
7. Water and Moisture – Do not use this product near water—for example, near a bath tub, wash bowl, kitchen sink, laundry tub, swimming pool, in a wet basement, and the like.
8. Accessories – Do not place this product on an unstable cart, stand, tripod, bracket, or table. The product may fall, causing serious injury to a child or adult, and serious damage to the product. Use only with a cart, stand, tripod, bracket or table recommended by the manufacturer, or sold with the product. Any mounting of the product should follow the manufacturer's instructions, and should use a mounting accessory recommended by the manufacturer.
9. A product and cart combination should be moved with care. Quick stops, excessive force, and uneven surfaces may cause the product and cart combination to overturn.
10. Ventilation – Slots and openings in the cabinet are provided for ventilation and to ensure reliable operation of the product and to protect it from overheating. These openings must not be blocked or covered. The openings should never be blocked by placing the product on a bed, sofa, rug, or other similar surface. This product should not be placed in a built-in installation such as a bookcase or rack unless proper ventilation is provided or the manufacturer's instructions have been adhered to.
11. Power Sources – This product should be operated only from the type of power source indicated on the marking label. If you are not sure of the type of power supply to your home, consult your product dealer or local power company. For products intended to operate from battery power or other sources, refer to the operating instructions.
12. Power Cord Protection – Power supply cords should be routed so that they are not likely to be walked on or pinched by items placed upon or against them, paying particular attention to cords at plugs, convenience receptacles, and the point where they exit from the product.
13. Grounding or Polarization – This product may be equipped with a grounded polarized alternating-current line plug (a plug having one blade wider than the other and a ground prong). This plug will fit into the power outlet only one way. This is a safety feature. If you are unable to insert the plug fully into the outlet, contact your electrician to replace your obsolete outlet. Do not defeat the safety purpose of the polarized plug.
14. Protective Attachment Plug – The product is equipped with an attachment plug having overload protection. This is a safety feature. See Instruction Manual for replacement or resetting of protective device. If replacement of the plug is required, be sure the service technician has used a replacement plug

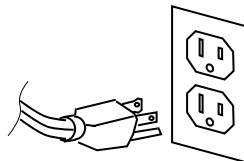

specified by the manufacturer that has the same overload protection as the original plug.

15. Outdoor Antenna Grounding – If an outside antenna or cable system is connected to the product, be sure the antenna or cable system is grounded so as to provide some protection against voltage surges and built-up static charges. Article 810 of the National Electrical Code, ANSI/NFPA 70, provides information with regard to proper grounding of the mast and supporting structure, grounding of the lead-in wire to an antenna discharge unit, size of grounding conductors, location of antenna-discharge unit, connection to grounding electrodes, and requirements for the grounding electrode. See Figure 1.
16. Lightning – Lightning – Unplug the unit from the wall outlet and disconnect the antenna or cable system for added protection during a lightning storm or when it is left unattended and unused for long periods of time. This will prevent damage to the product due to lightning and power line surges.
17. Power Lines – An outside antenna system should not be located in the vicinity of overhead power lines or other electric light or power circuits, or where it can fall into such power lines or circuits. When installing an outside antenna system, extreme care should be taken to keep from touching such power lines or circuits as contact with them might be fatal.
18. Overloading – Do not overload wall outlets, extension cords, or integral convenience receptacles as this can result in a risk of fire or electric shock.
19. Object and Liquid Entry – Never push objects of any kind into this product through openings as they may touch dangerous voltage points or short-out parts that could result in a fire or electric shock. Never spill liquid of any kind on the product.
20. Servicing – Do not attempt to service this product yourself as opening or removing covers may expose you to dangerous voltage or other hazards. Refer all servicing to qualified service personnel.
21. Damage Requiring Service – Unplug this product from the wall outlet and refer servicing to qualified service personnel under the following conditions:
  - a. When the power supply cord or plug is damaged.
  - b. If liquid has been spilled, or objects have fallen into the product.
  - c. If the product has been exposed to rain or water.
  - d. If the product does not operate normally by following the operating instructions. Adjust only those controls that are covered by the operating instructions, as an improper adjustment of other controls may result in damage and will often require extensive work by a qualified technician to restore the product to its normal operation.
  - e. If the product has been dropped or damaged in any way, and
  - f. When the product exhibits a distinct change in performance – this indicates a need for service.
22. Replacement Parts – When replacement parts are required, be sure the service technician has used replacement parts specified by the manufacturer or have the same characteristics as the original part. Unauthorized substitutions may result in fire, electric shock, or other hazards.
23. Safety Check – Upon completion of any service or repairs to this product, ask the service technician to perform safety checks to determine that the product is in proper operating condition.
24. Wall or Ceiling Mounting – The product should be mounted to a wall or ceiling only as recommended by the manufacturer.
25. Heat – The product should be situated away from heat sources such as radiators, heat registers, stoves, or other products (including amplifiers) that produce heat.

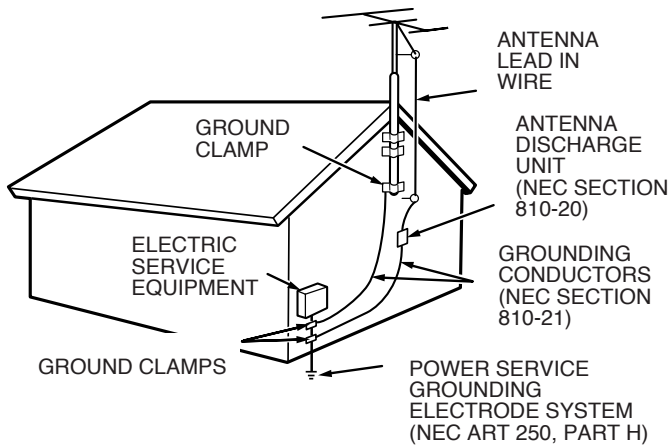

FIGURE 1  
EXAMPLE OF ANTENNA GROUNDING AS PER  
NATIONAL ELECTRICAL CODE, ANSI/NFPA 70  
NEC - NATIONAL ELECTRICAL CODE

### NOTE TO CATV SYSTEM INSTALLER:

This reminder is provided to call the CATV (Cable-TV) system installer's attention to Article 820-40 of the NEC, which provides guidelines for proper grounding and, in particular, specifies that the cable ground shall be connected to the grounding system of the building, as close to the point of cable entry as practical.

### NOTE:

This equipment has been tested and found to comply with the limits for a Class B digital device, pursuant to Part 15 of the FCC Rules. These limits are designed to provide reasonable protection against harmful interference in a residential installation. This equipment generates, uses and can radiate radio frequency energy and, if not installed and used in accordance with the instructions, may cause harmful interference to radio communications. However, there is no guarantee that interference will not occur in a particular installation. If this equipment does cause harmful interference to radio or television reception, which can be determined by turning the equipment off and on, the user is encouraged to try to correct the interference by one or more of the following measures:

- Reorient or relocate the receiving antenna.
- Increase the separation between the equipment and receiver.
- Connect the equipment into an outlet on a circuit different from that to which the receiver is connected.
- Consult the dealer or an experienced radio/TV technician for help.

**NOTE: Changes or modifications may cause this unit to fail to comply with Part 15 of the FCC Rules and may void the user's authority to operate the equipment.**

## WARNINGS

Do not expose the equipment to rain or moisture.

Do not remove the cover from the equipment.

Do not insert anything into the equipment through the ventilation holes.

Do not cover the ventilation with any items such as tablecloths, newspapers, curtains, etc.

No naked flame sources, such as lighted candles, should be placed on the equipment.

When setting up the recorder ensure that:

- it will not be exposed to interference from external equipment.
- it will not be exposed to electrostatic discharges.
- it will not be exposed to direct sunlight.
- heavy objects are not placed on the recorder.

### Copyright

Recording and playback of any material may require consent. For further information refer to the following US ordinances:

- Copyright act of 1956
- Dramatic and Musical Performance Act 1958
- Performers Protection Acts 1963 and 1972
- any subsequent statutory enactments and orders

**CE marking (only EU version)**

- English**  
This product is in conformity with the EMC directive and low-voltage directive.
- Français**  
Cet appareil est conforme á la directive EMC et á la de directive sur les basses tensions.
- Deutsch**  
Dieses Greät entspricht den EMC-Richtlinien und den Richtlinien für Niederspannungsgeräte.
- Nederlands**  
Dit apparaat voldoet aan de EMC-richtlijnene en de richtlijnen voor apparatuur met laag voltage.
- Italiano**  
Quest' unità è conforme alle diretive EMC ed alla direttiva sulle basse tensioni.
- Português**  
Esta unidade está em conformidade com as directivas EMC e as directivas de baixa voltagem.
- Español**  
Esta unidad estáde acuerdo con las normas EMC y las relacionadas con baja tensión.

**Equipment mains working system**

This product complies with household power and safety requirements in your area.

---

**This Class B digital apparatus complies with Canadian ICES-003.**

Cet appareil numérique de la Classe B est conforme á la norme NMB-003 du Canada.

---

SI DICHIARA CHE L'APPARECCHIO SINTO-AMPLIFACATORE SR-39  
RISPONDE ALLE PRESCRIZIONI DELL'ART. 2 COMMA 1 DEL D.M. 28  
AGOSTO 1995 N° 548.

FATTO A EINDHOVEN, IL 1/1/1997.

MARANTZ EUROPE B.V.  
5600 EINDHOVEN  
THE NETHERLANDS

"Este aparato lleva elementos antiparasitarios necesarios para cumplir con ls limites que se estableren en el Anexo V del Reglamento sobre Pertubaciones Radioelectricas e Interferencias aprobado en el Real Decreto 138/1989. (B.O.E. de 9 Febrero 1989)."

## Table of Contents

### Precautions

Warnings and Cautions .....	2
Important Safety Instructions .....	3
Regulatory Compliance .....	4
Table of Contents .....	6
Package Contents .....	7
CF card .....	7
Introduction .....	8
Features .....	9
Basic installation and start-up .....	10
Recording setup .....	11
Controls and Connections	

<b>Front</b> .....	12
POWER ON/OFF button .....	12
HEADPHONE jack .....	12
LEVEL control .....	12
CF card access light .....	13
CF card compartment .....	13
Card eject button .....	13
To eject a CF card .....	13
To insert a CF card .....	13
CF card Security .....	13
DISPLAY button .....	14
LOCK button <b>LOCK</b> .....	14
Display .....	15
MENU/STORE <b>EDIT</b> button .....	17
Menu .....	17
Menu selections .....	17
EDIT Menu .....	17
Edit Menu selections .....	17
Rewind, Fast Forward button group .....	18
Rewind button ◀◀ .....	18
UNDO button .....	18
Fast Forward button ▶▶ .....	18
M. RESET button .....	18
Jog Wheel .....	18
How to select tracks during playback .....	19
How to select an EDL mark .....	19
How to adjust record level .....	19
How to adjust record balance .....	19
How to A-B repeat .....	19
SHIFT button <b>SHIFT</b> .....	20
Record/MARK button ● <b>MARK</b> .....	20
How to start a new track .....	20
How to add an EDL mark while recording .....	20
Stop/CANCEL button ■ .....	20
Play/Pause button ▶/   .....	20

<b>Back</b> .....	21
BALANCED IN	
ANALOG XLR inputs L&R .....	21
Trim L&R .....	21
ANALOG IN/OUT jacks .....	21
L&R ANALOG IN jacks .....	21
L&R ANALOG OUT jacks .....	22
DIGITAL IN & OUT connectors .....	22
DIGITAL IN jack (RCA) .....	22
DIGITAL OUT jack (RCA) .....	22
I/O port .....	22
REMOTE2 .....	22
RS-232C connector .....	23
REMOTE1 jack .....	23
Remote Menu setting .....	23
AC IN .....	23

### Editing and setup



Menu mode .....	23
Presets .....	23
How to switch Presets .....	23
Table of Preset defaults .....	24
Preset defaults .....	25
General Menu procedure .....	25
How to select input(s) for recording .....	25
How to set or change the Date and Time .....	26
How to set or change the Date Form .....	27
RecFormat .....	28
RecFormat parameters .....	28
How to set or change	
the RecFormat parameters .....	29
Pre Record .....	31
Auto Mark .....	31
Manual TR .....	32
Auto Trk .....	32
Minute Track .....	32
SeamlsPly (Seamless Play) .....	33
SilentSkp (Silent Skip) .....	34
Auto Cue .....	35
Play Mode .....	36
Normal .....	36
Repeat All .....	36
Repeat TRK .....	36
Single .....	36
EDL Play .....	37
Remote .....	37
ID1dscrpt, ID2Origin, ID3OrRef	
(Broadcast Wave ID Numbers) .....	38
Default (Menu Default) .....	39
<b>Edit Menu</b>	
Renummer (tracks) .....	40
TrkERASE .....	40

continues

TrkMkERASE .....	41
AllMkERASE .....	42
FORMAT (CF card) .....	42
To FORMAT a CF card .....	42
I/O port .....	43
How to connect via the I/O port .....	43
Diagram of file structure .....	43
EDL marks .....	44
Locating EDL Marks .....	44
EDL marks and the beginning of a Track .....	44
Custom playback sequences .....	44
How to Edit EDL Marks .....	45
EDL mark types .....	45
EDL Play .....	45
RS-232C Control Windows Application .....	46
RS-232C control .....	47
RS-232C specifications .....	47
Connector pin assignment .....	47
Physical specifications .....	47
Flow control and timing .....	47
Command format .....	47
Handshake flow charts for control command ..	48
Control command codes .....	48
Status Request and Status Information codes ..	48
Table of Control command codes .....	48
Table of Status Request and Status Information codes .....	50
Recording time chart .....	51
Troubleshooting .....	52
Care and maintenance .....	52
Error messages .....	52
Specifications .....	53
Limited Warranty .....	54

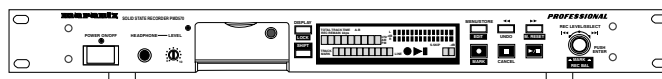
## Package contents

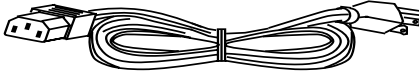
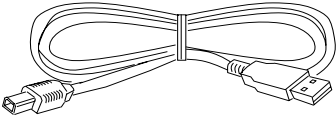
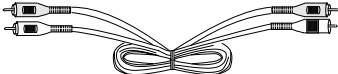

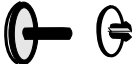
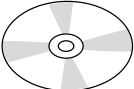
- PMD570
- 64MB CF card (US only)  
(shipped formatted and installed) 
- Power cord 
- I/O cable  
(6ft, 180cm) 
- Audio cable (2)  
(stereo pair)  
(3' 3", 100cm) 
- Security screw (2)  
ISO 3x10 (3mm x 10mm  
long)  
For Memory compartment  
door (1 spare) 
- Plastic pin and retainer  
(spare - for Memory compart-  
ment door) 
- CD-ROM  
Contents of the CD-ROM may vary.  
Contents usually include: 
  - PDF format manual(s)  
Several languages may be included.
  - Demonstration copy of Marantz Professional's  
PMDEdit application software
  - Instructions for obtaining full copy of Marantz  
Professional's PMDEdit application software
- This User Guide
- Customer Registration Document



## Introduction

Thank you for selecting the Marantz Professional PMD570 Solid State Recorder. The PMD570 is an audio recorder that records in digital audio formats onto a Compact Flash™ memory card (CF card) or Microdrive™.

Compact flash memory cards, also used in digital cameras, are widely available at consumer electronics retailers and computer resellers.

## Computer compatible

The PMD570 records directly onto CF cards. Recordings can be transferred to your desktop or laptop computer by removing the CF card from the PMD570 or by connecting the PMD570 to your computer via the I/O port. Audio recorded in the popular MP3 compression format is directly available for intranet or internet file sharing.

On your computer you can then:

- log and archive audio files
- play audio files
- save audio files to:
  - your hard drive
  - a floppy
  - a CD-R disc
- post streaming audio files on your web site
- use software and your computer to transcribe digital recordings
- An editing program (Marantz Professional's PMDEdit application software, available from Marantz Professional for PC users) lets you convert and edit audio files that were recorded on the PMD570.

## Setup

- Three menu selectable Presets make it easy to switch between your commonly used input, recording format, playback parameters and other menu selections.

**Audio inputs** may be from:

- line level sources connected to the BALANCED IN XLR jacks,
- line level audio sources connected to the ANALOG IN RCA jacks, or
- digital audio sources in SPDIF format connected to the DIGITAL IN jack.

**Audio outputs** may be from:

- headphones connected to the HEADPHONE jack,
- analog audio devices such as an amplifier or other device connected to the ANALOG OUT jacks, and/or
- digital audio devices using SPDIF format connected to the DIGITAL OUT jack.

## External control

- RS-232C control codes enable full external control of the PMD570.
- Suggested Presets that are downloadable to the PMD570 via the RS-232C control port are available at d-mpro.com.
- An optional wired Remote Marantz Model RC600 connects via a TRRS connector and permits:
  - starting, stopping, or pausing recording
  - adding EDL marks (see next page) to a track
- A second wired remote connection accepts a mono Phone jack (remote control not supplied). Depending on the menu selection a simple contact closure connected here permits:
  - Start Pause: pause and resume
  - StrtPausTR: restart after pause while recording initiates a new track
  - EDL Mark: add a silent EDL mark
  - Manual TRK: initiate a new track while recording (if Seamless Play is off during playback adds a small audio gap)

## Security - CF cards

For security the CF card compartment door can be secured with a screw. Requiring a tool to open the CF card compartment reduces casual removal of the CF card.

## Automatic recording

The PMD570 can be set to stop recording when there is silence (Silent Skip) and automatically start when sound resumes. The PMD570 can be set to automatically add an EDL mark to the track at each such starting point.

## Playback aids

A common problem with lengthy recordings is difficulty in locating one or more specific passages for playback. The PMD570 has several ways to mark or tag specific record starting and/or ending points.

- **Date and time**

A built-in date and time generator marks the beginning of each track.



## • Tracks

- A new track (file) is automatically started each time you begin a recording.
- It is not possible to record over a previously recorded track unless it is first erased.
- An Auto Track feature can add tracks every minute or other selectable recording interval. (**Minute track:** Setting the interval to one minute provides a new track every minute of a recording, permitting navigating a large audio recording by time.)
- A new track can be started during recording by pressing the Record button. (Manual TR, Manual Track incrementing, On.)

## EDL marks

EDL marks are silent during playback but locatable.

EDL (Edit Decision List) marks can be created during recording manually or automatically. EDL marks help you find those specific points in the recording.

\*The EDL marking system is proprietary to Marantz Professional solid state recorders.

- During playback you can instantly locate EDL marks.
- You can change an EDL mark into a skip mark or an A-B repeating point. That lets you create custom playback sequences which include skipping audio between EDL marks or repeating audio between EDL marks.
- EDL marks are specific to the CF card, not to Tracks. That lets you create custom playback sequences across Tracks.
- Up to 255 EDL marks can be added to a CF card. EDL marks are numbered consecutively starting at one.
  - During recording you can manually add an EDL mark by pushing and holding **SHIFT** while you push the **MARK** button.
  - EDL marks can also be added automatically.
- Marantz Professional's PMDEdit application software, is specifically designed by Marantz. Marantz Professional's PMDEdit application software recognizes EDL marks generated by the PMD570. This is especially useful for editing audio files on your PC. For more information visit [www.d-mpro.com](http://www.d-mpro.com).

## Features

- Stereo (2 channels) and mono (1 channel) audio recording and playback.
- Records onto various types of CF cards. (Please refer to the Marantz Professional web site at [www.d-mpro.com](http://www.d-mpro.com) for what kind of media are recommended.)
- Three different recording formats.
  - Compressed recording using MPEG1 Layer II (MP2) or MPEG1 Layer III (MP3) mono and stereo.
  - Uncompressed recording using 16-bit linear Pulse Code Modulation (PCM).
- MS-DOS™, Windows and Macintosh compatible audio files.
- Selectable file types:
  - Wave
  - Broadcast Wave Format
  - RAW MP2/MP3.
- recording bit rate is selectable
  - MP2/MP3 compressed at 32kbps (recommended for dictation), 32, 48, or 64kbps (recommended for voice recording), or 128, or 192 kbps (recommended for recording music)
  - PCM uncompressed at 768kbps (mono) (very high quality mono audio recording)
  - PCM uncompressed at 1536kbps (stereo) (recommended for very high quality audio recording)
- Pre-Recording memory buffer that records 2 seconds of audio before recording is started.
- Portions of multiple recordings can be played back in sequence using EDL marks.
- Built-in Time and Date generator marks the beginning of each track.
- Three remote options, including RS-232C, permit wired remote control.

## Basic installation and start-up

Follow the instructions on this page to install your new PMD570 Solid State Recorder and begin recording.

The PMD570 comes factory preset (Preset1) for recording in stereo with MP3 compression, recommended quality for music recording.

1. Rack mount the PMD570 or install on a stable cart or stand.
2. Connect line level analog inputs and/or outputs to the ANALOG IN/OUT jacks.

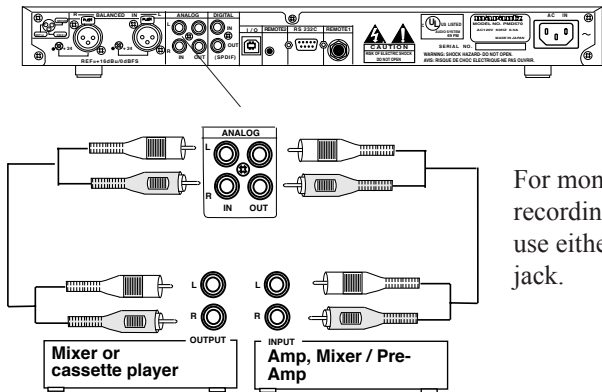

3. Connect line level XLR equipment for recording.

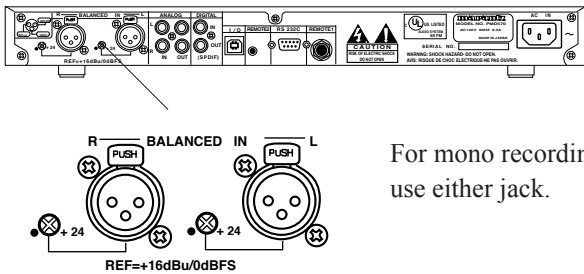

4. Connect DIGITAL input and/or output to SPDIF digital equipment for playing or recording.

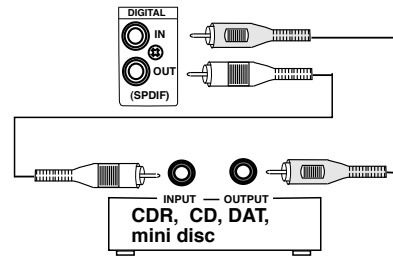
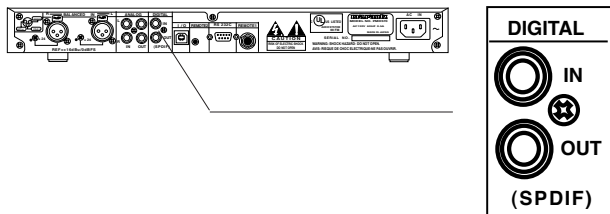

Connect a SPDIF coaxial digital audio cable to DIGITAL IN and/or DIGITAL OUT and then to output and/or input of your digital device. DIGITAL OUT signal is available while playing, recording or in record pause. DIGITAL IN Use this connection for recording. Digital input cannot be mixed with line level input via the ANALOG IN jacks.

5. Connect to your computer (PC or Mac) via the I/O port.

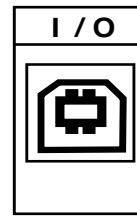
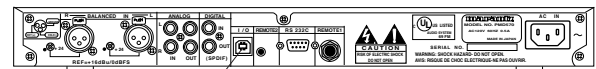

This connection makes it easy to copy audio files to or from your computer's hard drive to or from the PMD570 CF card.

The I/O connection can only be made active when the PMD570 is off (neither recording or during playback).

The CF card in the PMD570 appears as a removable drive on your computer.

6. Optional: connect external (remote) control,
  - 6a. RC600 wired remote control
  - 6b. RS-232C host equipment
  - 6c. wired remote with mono phone jack

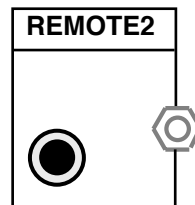
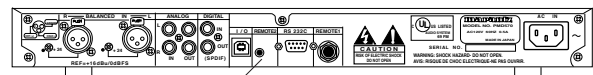

6a. Connect RC600 wired remote control to REMOTE2

Model RC600 has three buttons that let you start recording, record pause or add an EDL mark. See your Marantz Professional Audio dealer for ordering information.

## Basic installation and start-up continued

6b. RS-232C host equipment.

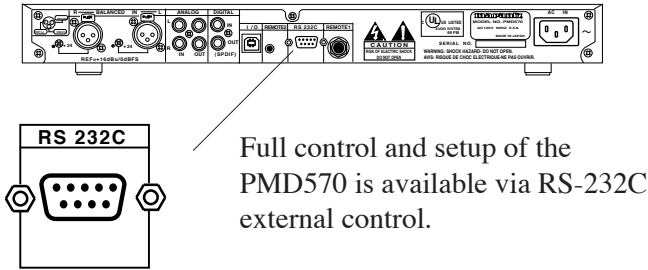

See page 47 for RS-232C control codes.

6b. Connect a wired remote switch with mono phone jack to REMOTE1.

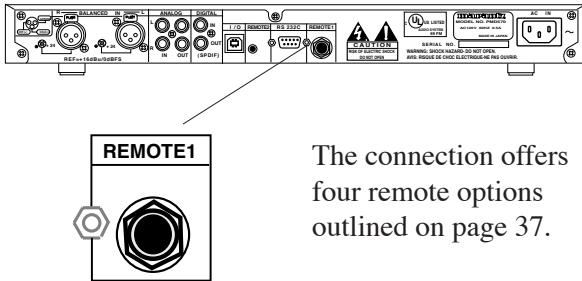

7. Use the supplied power cord to plug into 120 VAC power.

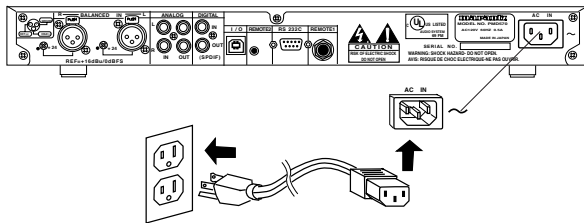

### Start-up

8. Install a CF card.

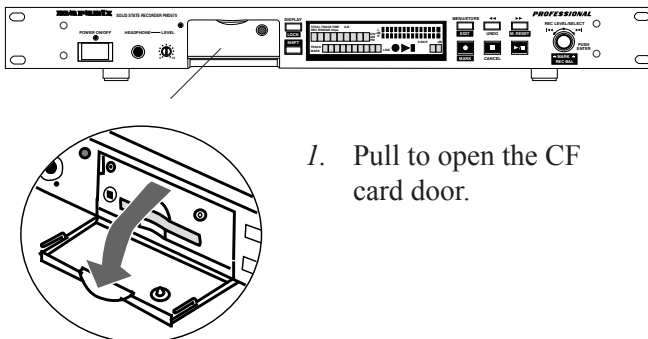

2. The Card eject button has two positions: click out (a) and click in (b). Leave or push the Card eject button so it is in the in (b) position.

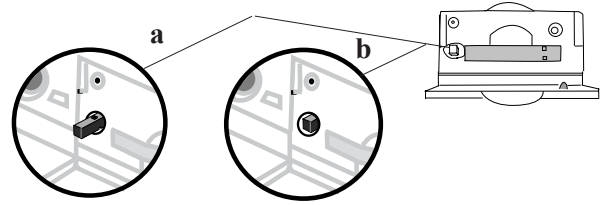

3. Insert a CF card.

4. Close the CF card door.

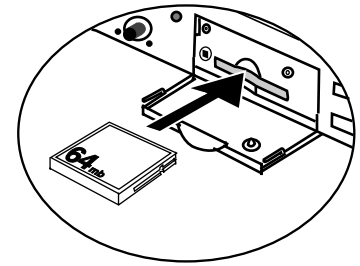

Note:

If the CF card door won't latch, check that the Card eject button is in the click in position (b above).

9. Push and release the POWER ON/OFF button.

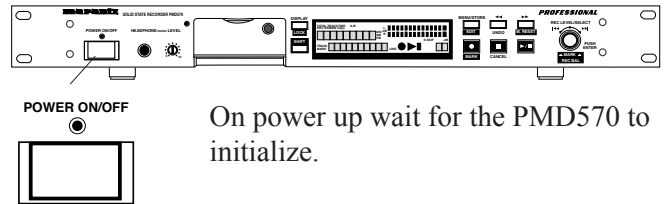

Loading appears momentarily.

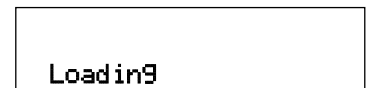

A full display appears.

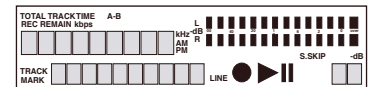

The display changes to Reading

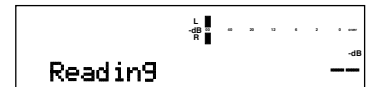

The display changes to the state of the CF card.

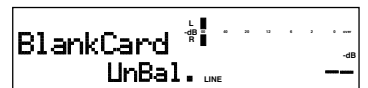

Example display shows a newly formatted CF card with default Preset1.

10. The PMD570 is ready to record. You may want to check or change the recording setup.

### Recording setup

The PMD570 is shipped setup (Preset1 default).

## Basic installation and start-up continued

All Preset default settings are outlined on page 51. [A 128MB CF card can record about 1 hour and 45 minutes at Preset1 default settings. See table on page 51.]

If your input is not line level audio via the ANALOG IN RCA jacks, you will need to change the Input Menu selection.

1. Push and release the MENU/STORE button.
2. Push and release the Jog Wheel to accept Preset1.

3. Turn the Jog Wheel so Input is displayed and flashing. Then push and release the Jog Wheel.



4. The input choice (Bal.In, UnBal., or Dig-In) is flashing. Turn the Jog wheel to scroll through the Input choices.

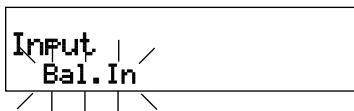

5. When correct push and release the Jog Wheel. Display returns to Input flashing.

6. Push and release the MENU/STORE button.

11. Push and release the Record button ●. PMD570 enters record pause.

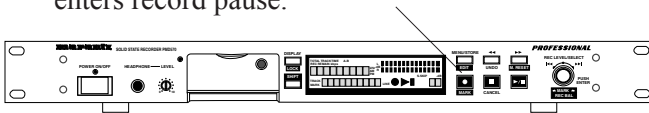

Example display

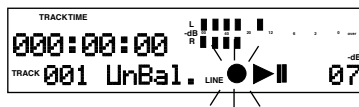

Push and release the Record button ● again. Recording begins.

The red light in the Record button is blinking during record pause and lit and steady during recording.

The display will show the recording time counting up (a) on the current track (b).

Example display

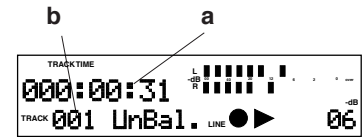

13. Push and release the Stop/CANCEL button ■ to stop recording and end the track (close the audio file).

The display will show the recording time on the track you just recorded.

example shows 0 hours 6 minutes and 23 seconds recorded on track 1

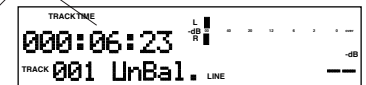

## Controls and Connections Front

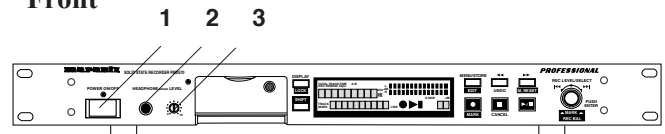

### POWER ON/OFF



**1. POWER ON/OFF button**  
Push and release to turn Power ON or OFF.

When powered up the PMD570 goes through a start-up procedure. See page 11.

### Note:

Standby power mode is available via RS-232C control only.

### HEADPHONE



**2. HEADPHONE jack**  
Plug stereo headphones in here. Headphones are active during recording, record pause and playback.

Adjust headphone volume with the LEVEL control.

### LEVEL



**3. LEVEL control**  
Turn to adjust headphone volume.

**Controls and Connections**  
**Front continued**

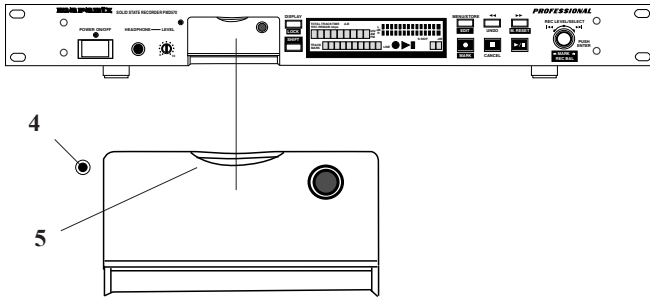

**4. CF card access light (green)**

Flashing while the CF card is being read from or written to.  
 Lit and steady while the CF card is ready.

**5. CF card compartment**  
 Pull to open to access the CF card  
 Door Open is displayed.

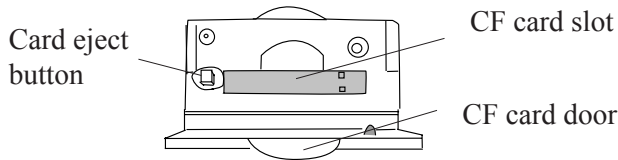
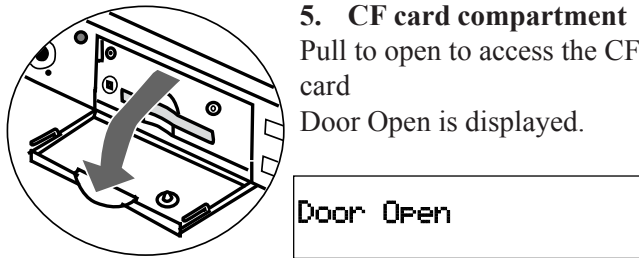

**Card eject button**

The Card eject button has two positions: click out (a) and click in (b).

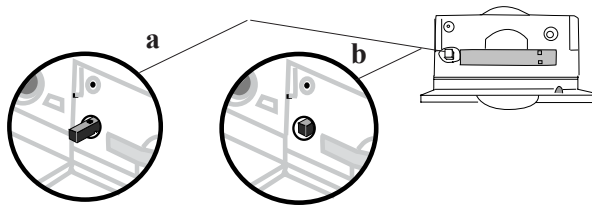

**To eject a CF card:**

1. If recording or in playback push STOP ■.  
 If other operations are in progress cancel them by pushing STOP ■ or wait for them to complete.
2. Open the CF card door.

**CAUTION**

If recording is in progress, opening the CF card door automatically stops recording and writes critical track information to properly close the file.

3. Push and release the Card eject button so it is in click out position (a).
4. To eject the card, push the Card eject button from the click out position to the click in position (b).

**To insert a CF card:**

1. Leave or push and release the Card eject button so it is in the click in position (b).
2. Fully insert the CF card.
3. Close the CF card door.

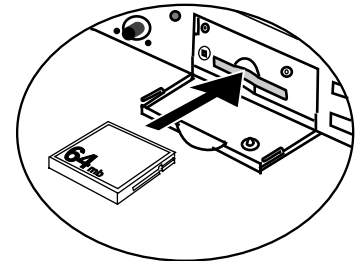

Note: If the CF card door won't latch, check that the Card eject button is in the click in position (b).

**CF card security**

The supplied CF card compartment security screw requires using a small Phillips screwdriver to open the CF card compartment door. That reduces the possibility that the CF card will be misplaced or stolen.

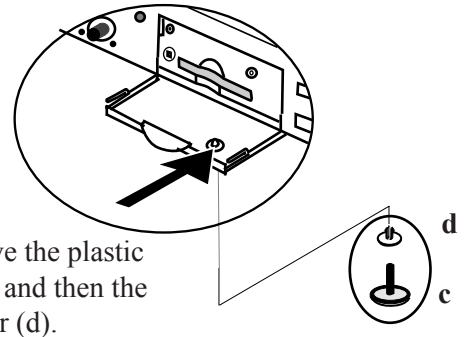
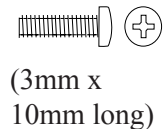

1. Remove the plastic pin (c) and then the retainer (d).
2. Add the screw. Tighten the screw with a small Phillips screwdriver tight enough so the screw cannot be removed with a fingernail.

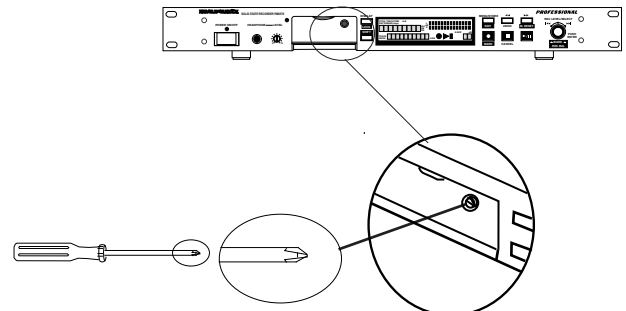

**Controls and Connections**  
**Front continued**

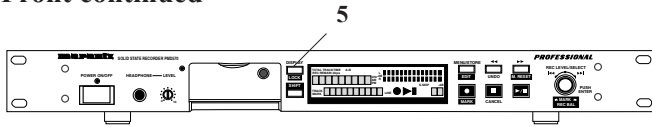

**5a. DISPLAY button**  
 Push and release to tab through alternate information displays.

Display information is slightly different in Stop, Record and Playback.

**During Stop:**  
 Default display is Remaining record time for the card.

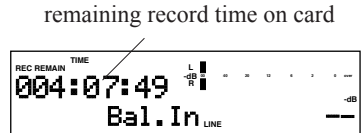

Example display

**After the first push** track information is displayed.

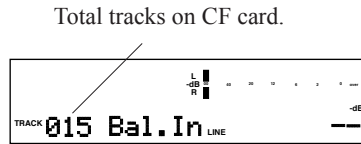

**After the second push** EDL mark information is displayed.

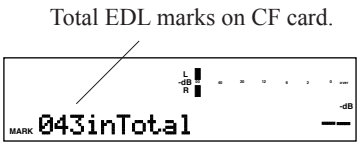

**After the third push** file parameters are displayed.

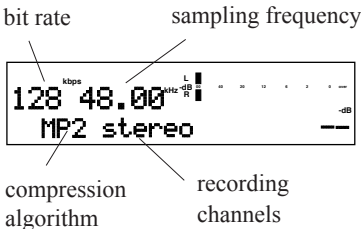

**After the fourth push** Date and Time information is displayed.

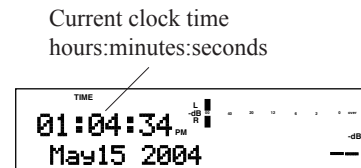

**After the fifth push** the display returns to the default: remaining record time on the CF card.

**During Record:**  
 Default display is elapsed Record time on the current track\*.

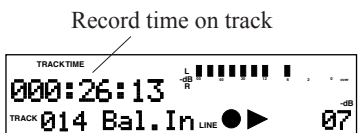

The first push of the DISPLAY button switches to remaining record time for the card.

The second push switches to file parameters.

The third push switches to date and time.

The fourth push returns to the default.

\*When there are 5 minutes of recording time remaining on the CF card, the display automatically switches to indicate remaining recording time on the CF card.

**During Playback** the default display is elapsed time on the current track.



The first push switches to track time remaining.

The second push switches to file parameters.

The third push switches to date and time.

The fourth push returns to the default.



**5b. LOCK button**  
 Push and hold **SHIFT** while you push and release the DISPLAY button to **LOCK** (or unlock) the keys (buttons and controls) on the PMD570.

KeyLocked is displayed briefly.

Example display

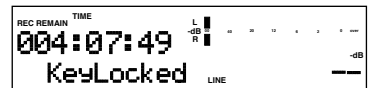

You can use LOCK to prevent front panel control of the PMD570.

When locked attempting to use controls (buttons or Jog Wheel) results in a brief "Locked" display.

Example display

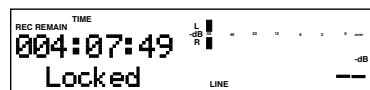

To unlock push and hold **SHIFT** while you push and release the DISPLAY button. "UnLocked" is displayed briefly. Powering off and back on also unlocks the controls.



## Controls and Connections

### Front continued

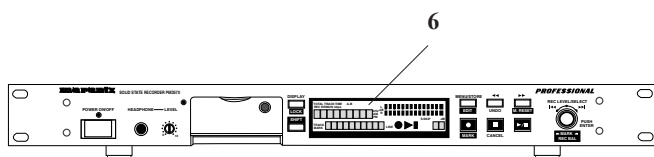

### 6. Display

Labels, icons, meters and alphanumeric messages communicate the status of the PMD570.

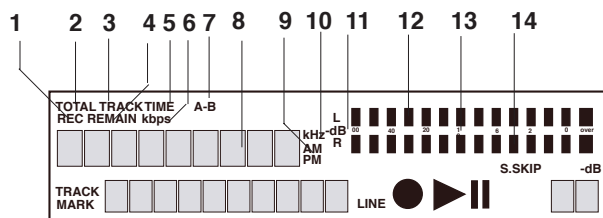

#### 1. REC label

The REC label appears with other labels in this area to indicate the upper alphanumeric display reflects recording time.

#### 2. TOTAL label

The TOTAL label appears with other labels in this area to indicate the upper alphanumeric display reflects total time.

#### 3. TRACK label

The TRACK label appears with other labels in this area to indicate TRACK TIME displayed on the upper alphanumeric display.

#### 4. REMAIN label

The REMAIN label appears with other labels in this area to indicate recording time remaining is displayed on the upper alphanumeric display.

#### 5. TIME label

The TIME label appears with other labels in this area to indicate recording time remaining, or track time is displayed on the upper alphanumeric display.

#### 6. kbps label

The kbps label appears to indicate that the first five places in the upper alphanumeric display are kilobits per second.

#### 7. A-B label

A- indicates that the beginning (A point) of an A-B loop has been set.

A-B indicates that the ending (B point) of an A-B loop has also been set.

#### 8. Upper alphanumeric display

Displays a variety of information including remaining recording time, clock time, menu settings etc. Associated labels are display items 1-7 and 9-10.

#### 9. AM / PM label

Displays AM or PM when clock time is displayed. AM and PM are flashing after a preset is set to default to remind you that the time has not been set.

#### 10. kHz label

The kHz label appears to indicate that the last five places in the Upper alphanumeric display is frequency in kilohertz.

#### 11. L -dB R level meter labels

L is the label for the upper (Left) level meter.

-dB is the label for the center level meter scale in decibels.

R is the label for the lower (Right) level meter.

#### 12. Upper level meter

The louder the sound input to the PMD570 on the Left /mono channel the more bars are displayed.

#### 13. Decibel scale

The scale in dB (decibels) for the upper and lower level meters.

#### 14. Lower level meter

The louder the sound input to the recorder on the Right channel the more bars are displayed.



**Controls and Connections**  
**Front continued**

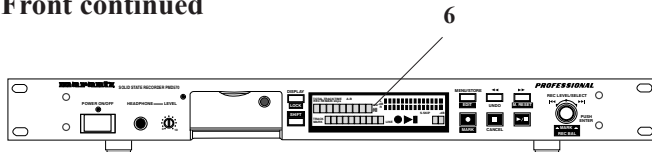

**6. Display continued**

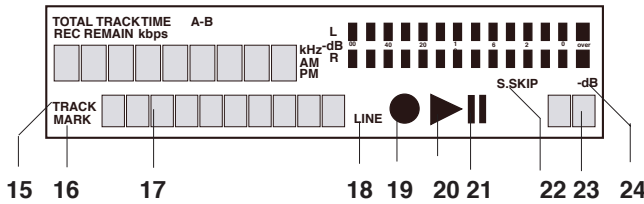

**15. TRACK label**

The TRACK label appears to indicate that the number displayed on the left of the lower alphanumeric display refers to track.

**16. MARK label**

The MARK label appears to indicate that the number displayed on the left of the lower alphanumeric display refers to EDL marks.

**17. Lower alphanumeric display**

Displays a variety of information including remaining recording algorithm, date, track number, number of tracks on CF card, EDL Mark number, number of EDL Marks on CF card etc. Associated labels are display items 15 and 16.

**18. LINE label**

The LINE label appears when the input Menu selection for recording is Bal.IN or UnBal.

**19. Record icon ●**

The Record icon appears when the PMD570 is in record mode. Appears with the Play icon when recording. Appears flashing when in record pause.

**20. Play icon ►**

The Play icon appears when the PMD570 is in playback, play pause, recording, or record pause.

**21. Pause icon ||**

The Pause icon appears when the PMD570 is in playback pause, or record pause.

**22. S.SKIP label**

The Silent Skip label appears when Silent Skip is enabled.

**23. Margin level**

The Margin level is displayed. The PMD570 holds this display at the highest level achieved during the current recording. If more than 0 dB, OV (over) is displayed. To reset the Margin level push and hold the **SHIFT** button while you push and release the **M. RESET** button.

**24. -dB label**

The -dB label applies to the Margin level display.

**Controls and Connections  
Front continued**

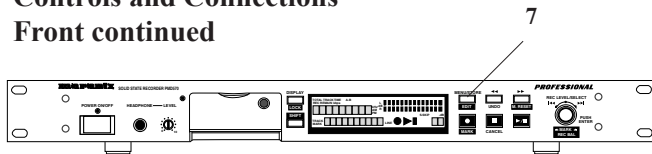

**7. MENU/STORE EDIT button**

There are two Menu selections  
Menu and EDIT Menu

**7a. Menu**

Menu, accessed from stop by pushing and releasing the MENU/STORE button, lets you set or change recording and playback parameters, such as changing inputs and setting the Date and Time.

**How to change Presets**

From stop, push and release the MENU/STORE button to enter Menu mode.

The currently selected Preset (1, 2 or 3) will be displayed and flashing.

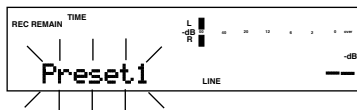

Turn the Jog Wheel to scroll through Presets 1, 2 and 3. Push and release the Jog Wheel to select the displayed Preset.

The menu for the selected Preset will be displayed with the parameter flashing.

Example display

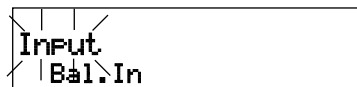

See page 25 for how to change Menu parameters.

When in a Menu mode push and release MENU/STORE to record and store menu changes. Or push and release the CANCEL button ■ to exit the Menu mode without storing any changes.

**Menu selections:**

<b>Menu item</b>	<b>see page</b>
PRESET 1, 2, 3 .....	17
Input .....	25
Date/Time .....	26
Date Form .....	27
RecFormat .....	28
PreRecord .....	31
Auto Mark .....	31
Manual TR .....	32
Auto Trk .....	32
SeamlsPly .....	33
SilentSkp .....	34
Auto Cue .....	35
Play Mode .....	36
EDL Play .....	37
Remote .....	37
ID1Dscript .....	38
ID2Origin .....	38
ID3OrRef .....	38
Default .....	39

**7b. EDIT Menu**

Edit Menu, accessed from stop by pushing and holding **SHIFT** while pushing and releasing the MENU/STORE button, lets you erase and renumber tracks, erase EDL marks, and format the CF card.

**Edit Menu selections:**

<b>Edit Menu item</b>	<b>see page</b>
Renumber .....	40
TrkERASE .....	40
TrkMkErase .....	41
AllMkERASE .....	41
FORMAT (CF card) .....	42

## Controls and Connections Front continued

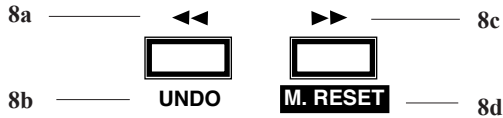
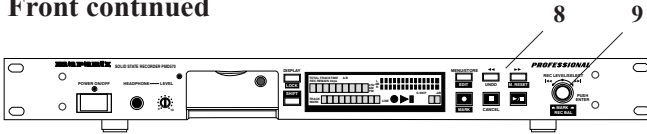

### 8. Rewind, Fast Forward button group.



#### 8a Rewind button ◀◀

During playback push and hold to rewind, do an audible search in the reverse direction.

During play pause, push and hold to rewind quickly.



#### 8b UNDO button

During record push and release to undo the recorded track (restart the same track at the beginning).

When recording a live session, you can check that inputs are working properly, set the recording level and precisely start recording.

When recording and the UNDO button is pushed and released, REC Undo? is displayed for about 3 seconds. If the UNDO button is pushed and released while REC Undo ? is displayed, the track is reset and paused at 00:00:00. Recording continues if REC Undo times out.

Example display before pressing the UNDO button

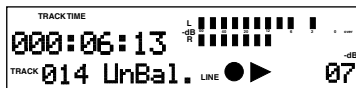

REC Undo?  
displayed for 3 seconds.

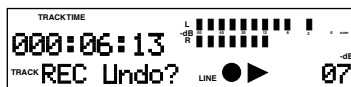

Example display if the UNDO button pushed and released while REC Undo ? is displayed.

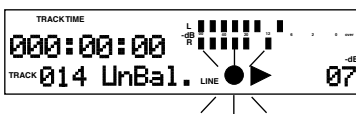

#### 8c Fast Forward button ▶▶

During playback push and hold to fast forward, do an audible search in the forward direction.

During play pause, push and hold to fast forward quickly.



#### 8d M. RESET button

During record, record pause or playback push and hold the **SHIFT**

button and push and release the M. RESET button to reset the peak level margin.

Example display with level margin at -02dB before pushing the M. RESET button.



level margin

The level margin displays the highest level achieved since the track began or the M. RESET button was pushed and released. OV indicates a margin over 0dB.

#### Notes:

If the Rewind button ◀◀ or the Fast Forward button ▶▶ is held past the beginning or end of a track the rewind or fast forward will continue onto the previous or next track.

If Play Mode Single or Play Mode Repeat All is on, the rewind or fast forward will follow the repeat order.

Rewind button ◀◀ and Fast Forward button ▶▶ do not function in EDL playback or EDL A-B repeat.

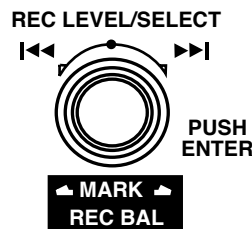

### 9. Jog Wheel

This is a main control which changes function depending on the state of the PMD570

Turn to:

- choose the track (during stop or playback)
- + **SHIFT** choose an EDL mark (during stop or playback)
- adjust recording level (during rec pause or recording)
- + **SHIFT** adjust recording balance (during rec pause or recording)
- scroll through settings (Menu or Edit Menu)

## Controls and Connections

### Front continued

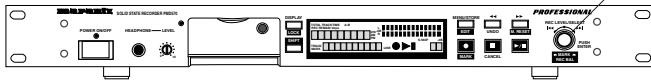

## 9. Jog Wheel continued

Push and release the Jog Wheel to:

- + **SHIFT** select the displayed EDL mark for playback or editing
- select displayed setting (Menu or Edit Menu)
- set A-B repeat position (during playback)

### How to select tracks during playback

Turn the Jog Wheel to choose the track when in stop, play or play pause.

The PMD570 switches to the beginning of that track.

### How to select an EDL mark

When in stop, playback or play pause, push and hold **SHIFT** and turn the Jog Wheel to choose an EDL mark. The PMD570 jumps to the selected mark.

Example display

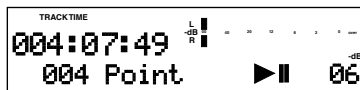

Note:

Nothing happens if there are no EDL marks on the CF card.

When the desired EDL mark is displayed, release the **SHIFT** button to jump to that mark.

- Push and release the Play/Pause button ►/|| to start or continue playback from the EDL mark.
- Push and release the Jog Wheel to edit the EDL mark type. See How to edit EDL marks, page 45.

### How to adjust record level

Turn the Jog Wheel to set or adjust the record level (Vol.) during recording or in record pause.

Example display

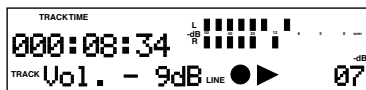

The record level can be from 0 to -78 dB.  
Turn slowly to adjust 1 dB at a time.  
Turn fast to adjust 5 to 15 dB at a time.

The record level setting is remembered, even after power off, you do not have to do anything to confirm or store it.

### How to adjust record balance

First check or adjust the record level (above). Push and hold **SHIFT** while you turn the Jog Wheel to set or adjust the record balance during recording or in record pause.

Record balance maintains the record level of the target channel and reduces the record level of the other channel in 1 dB increments. For example, if you press and hold **SHIFT** and turn the Jog Wheel 5 clicks to the right, the right channel record level is not changed, and the left channel record level is reduced 5dB.

Balance is displayed graphically.

Example display



The LR Balance bar displays up to 18 (1dB) clicks of the Jog Wheel to the right or 18 clicks to the left.

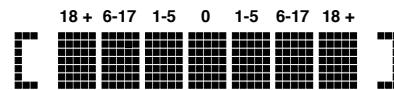

When balance is as desired, release the **SHIFT** button.

The record balance setting is remembered, even after power off, you do not have to do anything to confirm or store it.

### How to A-B repeat

During playback push and release the Jog Wheel to set the A point.

Example display

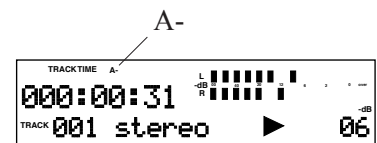

Push and release the Jog Wheel again to set the B point.

Example display

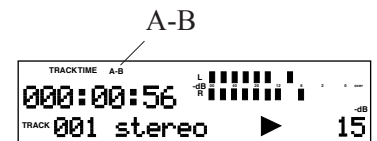

Playback repeats endlessly between the A and B points.

continues

## Controls and Connections Front continued

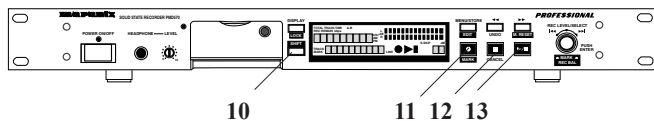

### How to A-B repeat continued

To exit A-B repeat push and release the Jog Wheel. A-B repeat is cancelled and playback is paused at the B point.

Example display



Push and release the Play/Pause button ►/|| to continue playback from that point, or

Push and release the Jog Wheel to set the former B point to a new A point and remain in pause, or

push and release CANCEL ■ to cancel playback.



#### 10. SHIFT button

Push and hold while you push and release other controls (black labels) to activate alternate functions.



#### 11. Record/MARK button

(● / MARK)

Button is lit (red) and flashing while in record pause.

Button is lit (red) and steady while recording.

### How to start a new track

From stop push and release the Record button ● to enter record pause at the start a new track. Push and release the Record button ● again to begin recording.

When Manual TR is On, while recording, push and release the Record button ● to start a new track and continue recording. A small audio gap is inserted between the tracks. See Seamless Play, page 33, to avoid the audio gap during playback.

### How to add an EDL mark while recording

While recording, push and hold the SHIFT button while you push and release the Record MARK button to add an EDL mark.

Notes:

EDL marks are numbered specific to the CF card not the track.

EDL marks are numbered consecutively starting at 1 up to a maximum of 255 EDL marks per CF card.

During playback EDL marks are silent and during EDL Play, do not result in a pause or audio gap.



#### 12. Stop/CANCEL button ■

Push and release to Stop or CANCEL an operation.

During recording push and release Stop ■ to stop recording and end the track. The display switches to information about the just recorded track.

Example display

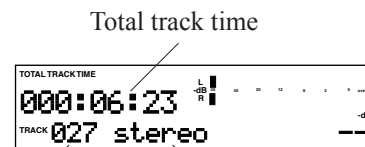

Track number channel(s) recorded

You can push and release Play/Pause ►/|| to play the just recorded track, or push and release Stop ■ again to enter stop mode. Pushing and releasing Play/Pause ►/|| will play the beginning of the first track.

During playback push and release Stop ■ to stop playback. When playback resumes, by pushing and releasing Play/Pause ►/||, playback begins at the beginning of the first track.

During Menu and Edit Menu operations push and release CANCEL ■ to cancel all Menu or Edit Menu changes and exit Menu or Edit Menu mode.



#### 13. Play/Pause button ►/||

From Stop push and release to begin playback.

During playback push and release to pause playback.

During playback pause, push and release to resume playback.

During recording push and release to Rec pause.

During Rec pause, push and release Record ● to resume recording. If Auto Mark is ON, an EDL mark is placed when recording resumes.

**Back**

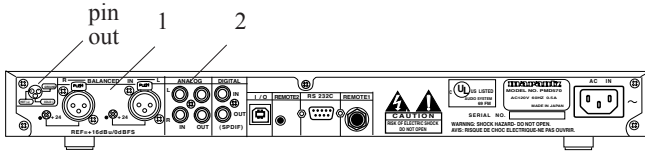

**1. BALANCED IN  
ANALOG XLR inputs, L & R**

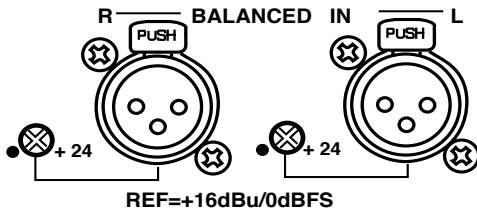

XLR connectors are available for balanced analog input.

The balanced XLR connection permits trimming, adjusting the input level. See TRIM L & R below.

For mono recording use either jack. Input from both jacks is mixed internally during mono recording. Mono recording will appear on the left level meter.

To record an incoming signal from the XLR jacks, Bal.In must be selected in the Input Menu.

Example display at stop.

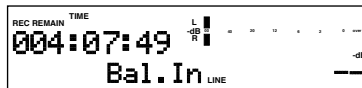

To select BALANCED IN XLR jacks as inputs for recording:

1. Push and release the MENU/STORE button.
2. Choose a Preset by turning the Jog Wheel.
3. Select the Preset by pushing and releasing the Jog Wheel.
4. Turn the Jog Wheel so Input is flashing.
5. Push and release the Jog Wheel so the input choice is flashing.
6. Turn the Jog Wheel so Bal.In is flashing.
7. Push and release the Jog Wheel to accept the Bal.In choice.
8. Push and release the MENU/STORE button to store the Menu change. Stored is displayed.

See page 24 for a full presentation of Menu selection.

**Trim L & R**

You can use a small screwdriver to adjust the Trim of the XLR L & R inputs.

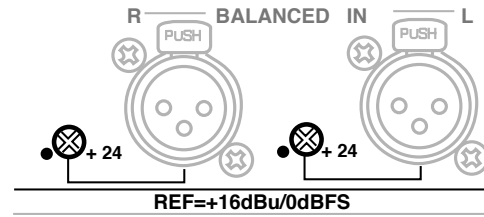

The Trim is factory preset at +16 dBu with an adjustment range from 0 to +24 dBu.

Some professionals prefer to first set the Trim using a meter and to do a fine adjustment by listening for distortion and watching the level meters on the PMD570.

The pin out for the XLR jacks is printed on the PMD570 for easy reference:

Pin 1 ground,  
Pin 2 HOT +,  
Pin 3 COLD -

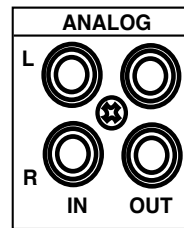
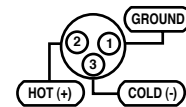

**2. ANALOG IN / OUT jacks**  
RCA jacks for line level input and output.

**L & R ANALOG IN jacks**  
Plug L and R RCA jacks in here to connect to the Line level

output jacks of an external mixer or other audio playback device.

For mono recording use either jack.

To record, UnBal. must be selected in the Input Menu.

Example display at stop.

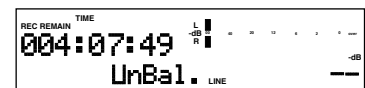

To select ANALOG IN RCA jacks as inputs for recording:

1. Push and release the MENU/STORE button.
2. Choose a Preset by turning the Jog Wheel.
3. Select the Preset by pushing and releasing the Jog Wheel.
4. Turn the Jog Wheel so Input is flashing.
5. Push and release the Jog Wheel so the input



**Back continued**

2 3 4 5

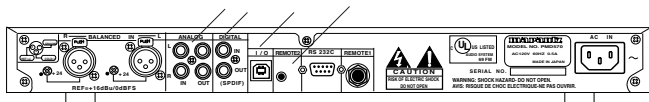

**2. ANALOG IN / OUT jacks continued**

choice is flashing.

6. Turn the Jog Wheel so UnBal. is flashing.
7. Push and release the Jog Wheel to accept the UnBal. choice.
8. Push and release the MENU/STORE button to store the Menu change. Stored is displayed.

See page 24 for a full presentation of Menu selection.

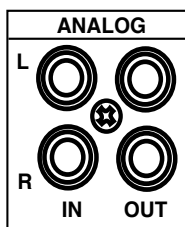

**L & R ANALOG OUT jacks**  
 Plug L and R RCA jacks in here to connect to the Line level input jacks of an external pre-amplifier, mixer or recording device.  
 This connection will pass a line level signal during recording, record pause and playback.



**3. DIGITAL IN & OUT connectors (SPDIF)**  
 Digital audio cable with RCA jacks can be used for input and output.

**DIGITAL IN jack (RCA)**

Connect a digital audio cable with an RCA jack from an external device providing SPDIF digital output\*. To record from this input Dig-In must be selected from the input menu.

\*Incoming source must be at 44.1 or 48 kHz.

Example display at stop.

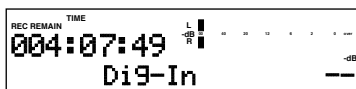

To select the DIGITAL IN jack as input for recording:

1. Push and release the MENU/STORE button.
2. Choose a Preset by turning the Jog Wheel.
3. Select the Preset by pushing and releasing the Jog Wheel.
4. Turn the Jog Wheel so Input is flashing.
5. Push and release the Jog Wheel so the input choice

is flashing.

6. Turn the Jog Wheel so Dig-In is flashing.
7. Push and release the Jog Wheel to accept the Dig-In choice.
8. Push and release the MENU/STORE button to store the Menu change. Stored is displayed.

See page 24 for a full presentation of Menu selection.

**DIGITAL OUT jack (RCA)**

Connect a digital audio cable with RCA jacks to an external device accepting a SPDIF digital input. This connection will pass a digital signal when the PMD570 is recording, in record pause or during playback.

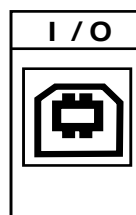

**4. I/O port**

Plug an I/O cable in here and connect the other end to your computer (PC or MAC).

**To activate I/O:**

From power off, push and hold the MENU/STORE button while you power on by pushing and releasing the POWER ON/OFF button.

The connection makes it easy to copy audio files to your computer's hard drive. The I/O connection can only be made active when the PMD570 is off (neither recording or during playback).

See page 43 for a full discussion of the I/O connection.

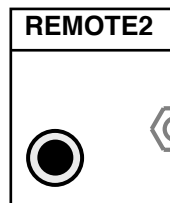

**5. REMOTE 2**

The REMOTE2 jack accepts the optional wired remote Marantz model RC600. Model RC600 has a record indicator light.

Model RC600 permits:

- starting recording
- pausing recording, and
- adding EDL marks

Model RC600 connects via a TRRS (Tip Ring Ring Sleeve) connector.



**Back continued**

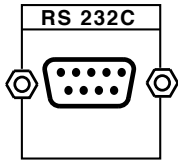
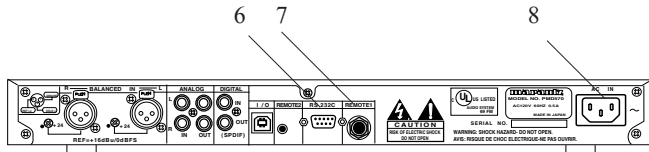

**6. RS-232C connector**

Using serial communication, a host device can control the PMD570.

- The RS-232C host can control functions of the PMD570 externally.
- The PMD570 automatically transmits status data when status is changed.
- The PMD570 will respond to a status request by transmitting the associated status data.

See RS-232C control, page 47, for details.

With Marantz Professional's PMD570 control setup application (check the enclosed CD ROM or see [www.d-mpro.com](http://www.d-mpro.com) to download) you can control the PMD570 from your PC. See page 46 for a brief description of the application.

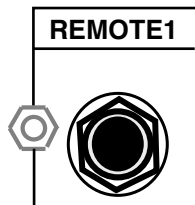

**7. REMOTE1 jack**

REMOTE1 accepts a remote (not supplied) that connects via a TS 1/4 inch plug.

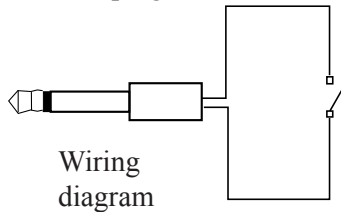

A connected switch on closing and on opening does the following depending on the Remote Menu setting.

**Remote Menu setting:**

**StartPause**

Close to start open to pause during recording or playback. If Auto Mark is ON and EDL mark is added when recording resumes.

**StrtPausTR**

Close to start, open to pause during recording or playback. Start after a record pause, continues on the next track.

**EDL Mark**

During record or playback close to add an EDL mark.

**Manual TRK**

During recording, close to increment the track. A new track is created at that point. There is no break in recording.

REMOTE1 behavior depending on switching activity:

	Remote Menu setting			
	StartPause	StrtPausTR	EDL Mark	Manual TRK
open → closed	Start	Start next track	add EDL mark	create new track
closed → open	Pause	Pause	-	-

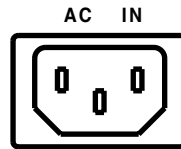

**8. AC IN**

Connect the 3 prong AC power cord.

**CAUTION:**

Only use the supplied power cord.

**Menu mode**

**Presets**

Three menu selectable Presets make it easy to switch between commonly used input, recording setup, and playback conditions. Called Preset1, Preset2, and Preset3.

**How to switch Presets**

From stop, push and release the MENU/STORE button to enter Menu mode.

The currently selected Preset (1, 2 or 3) will be displayed and flashing.

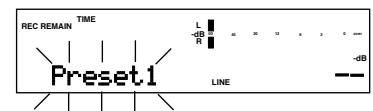

Turn the Jog Wheel to scroll through Presets 1, 2 and 3. Push and release the Jog Wheel to select the displayed Preset.



The Input menu for the selected Preset will be displayed.

You can edit the menu for the chosen Preset. To accept the menu settings, push and release the MENU/STORE button. The display returns to stop.

Table of Preset defaults

Display	Selection range	Default Setting (America)			Default Setting (Europe)		
		Preset 1	Preset 2	Preset 3	Preset 1	Preset 2	Preset 3
Input	Bal.In, UnBal., Dig-In	UnBal.	UnBal.	Bal.In	UnBal.	Bal.In	UnBal.
Date Time	2003 - 2099	2004	2004		2004		
	JAN - DEC	JAN	JAN		JAN		
	1 - 31	1	1		1		
DateForm	AM/PM 0:00 - 11:59	AM 0:00	AM 0:00		AM 0:00		
	M/D/Y, D/M/Y	M/D/Y	M/D/Y		D/M/Y		
RecFormat	Stereo/Mono	Stereo	Mono	Stereo	Stereo	Stereo	Stereo
	PCM/MPEG2/MPEG3	MP3	MP3	PCM	PCM	PCM	MP3
	16/22.05/24/32/44.1/48 (kHz)	44.1	44.1	44.1	44.1	48	44.1
	384 - 32 (kbps)	160	32	N/A	N/A	N/A	160
	wave/BWF/mp2/mp3 (File Format)	mp3	mp3	wave	wave	wave	mp3
	wav/bwf (BWF Extension)	wav	wav	wav	wav	wav	wav
PreRecord	On/Off	On	On	Off	On	On	On
Auto Mark	On/Off	On	On	Off	On	On	On
ManualTR	On/Off	On	On	On	On	On	On
Auto TRK	On/Off	Off	On	Off	Off	Off	Off
	1/5/10/15/30 min, 1/2/6/8/12/24 hrs	5 min*	5 min*	5 min*	5 min*	5 min*	5 min*
Seamls Ply	On/Off	Off	Off	Off	Off	Off	Off
SilentSkp	On/Off	Off	Off	Off	Off	Off	Off
	1 - 5 sec (1 sec steps)	3 sec*	3 sec*	3 sec*	3 sec*	3 sec*	3 sec*
	-60 - -20dB (5dB steps)	-40dB*	-40dB*	-40dB*	-40dB*	-40dB*	-40dB*
Auto Cue	On/Off	Off	Off	Off	Off	Off	Off
	5 - 95 msec (5 msec steps)	20 msec*	20 msec*	20 msec*	20 msec*	20 msec*	20 msec*
	-60 - -20dB (5dB steps)	-40dB*	-40dB*	-40dB*	-40dB*	-40dB*	-40dB*
Play Mode	Normal/Repeat All/Repeat TRK/Single	Normal	Normal	Normal	Normal	Normal	Normal
EDL Play	On/Off	Off	Off	Off	Off	Off	Off
Remote	StartPause/StrtPausTR/EDL Mark/Manual TRK	StartPause	EDL Mark	Manual TRK	StartPause	StartPause	StartPause
ID1Dscrpt	6-digit ASCII code	000000	000000	000000	000000	000000	000000
ID2Origin	6-digit ASCII code	000000	000000	000000	000000	000000	000000
ID3OrgRef	6-digit ASCII code	000000	000000	000000	000000	000000	000000
Default	---						
Application:		Music Compressed	Meeting Compressed	Highest Quality Uncompressed	High Quality Uncompressed	Highest Quality Uncompressed	Music Compressed

\*Default when the function has been set to On.

## Preset defaults

The default Menu settings for Presets 1, 2 and 3 can be restored by the Default Menu choice, page 39.

Preset1 default uses the unbalanced (ANALOG IN RCA jacks), line level, inputs. It is set for stereo channel music recording with MP3 compression. Selecting a higher bit rate (kbps) will improve audio quality but decrease available recording time.

Preset2 default uses the unbalanced (ANALOG IN RCA jacks), line level, inputs. It is set for Mono channel recording with MP3 compression. The settings are appropriate for recording meetings: quality acceptable for voice recording, long recording times possible, and capability to transfer files on internet.

Preset3 default uses the balanced (BALANCED IN XLR jacks) inputs. It is set for stereo channel CD quality recording with no compression.

See chart below on page 24 for complete default settings.

### Note:

Setting any preset to default resets the main clock. We recommend you set the date when you set a preset to default. See page 26.

### General Menu procedure:

1. With the PMD570 at Stop, push and release the MENU/STORE button.
2. Turn the Jog Wheel to scroll to the choice within Menu.
3. When displayed push and release the Jog Wheel to select that Menu choice.
4. Turn the Jog Wheel to scroll through the sub-menu displays.
5. When the desired parameter or value is displayed push and release the Jog Wheel to select it.
6. Repeat steps 2-5 as desired.
7. When done push and release the MENU/STORE button to save your changes, or push and release the Stop CANCEL button ■ to cancel them.

### How to select input(s) for recording

Audio input(s) and audio channels for recording are selected using the Input Menu.

1. From stop push and release the MENU/STORE button.

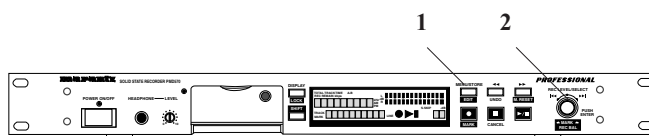

2. Turn the Jog Wheel to select Preset1, 2 or 3.

3. Push and release the Jog Wheel to accept the selected Preset.

4. Turn the Jog Wheel so Input is displayed and flashing.



5. Push and release the Jog Wheel while Input is displayed and flashing. The input choice (Bal.In, UnBal., or Dig-In) is flashing.

Example display

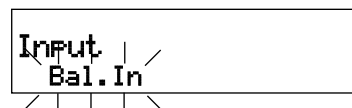

6. Turn the Jog Wheel to tab through the input choices.

7. When correct push and release the Jog Wheel. Display returns to Input flashing.

8. Turn the Jog Wheel to select other Menu choices for editing. When editing the Preset is complete push and release the MENU/STORE button to accept the changes, or push and release the CANCEL button ■ to exit Menu mode without making any changes.

### Notes:

- The Bal.In and Unbal. input choices are line level inputs. LINE is displayed on the stop and record displays.

Example display

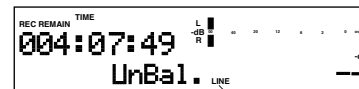

LINE

- The PMD570 records only from the selected input. For example if the input selected Bal.In and no input source is connected to the XLR jacks the PMD570 will record silence. Watch the level meters while in record pause, if the level stays at one display bar check for the proper input selection.

### How to set or change the Date and time

The date and time are written on each audio track (file) when the track is started. When an audio track is viewed on a computer this date and time appears as when the file was 'modified'. (US Date Form is illustrated.)

1. From stop push and release the MENU/STORE button.
2. Turn the Jog Wheel to select Preset1, 2 or 3.
3. Push and release the Jog Wheel to accept the selected Preset.
4. Turn the Jog Wheel so Date/Time is displayed and flashing.

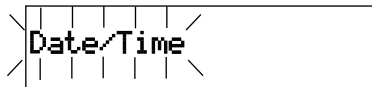

5. While Date/Time is flashing push and release the Jog Wheel. Date and time information will be displayed with the month flashing.

Example display

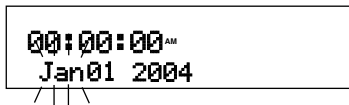

6. Turn the Jog Wheel until the current month is displayed.
7. Push and release the Jog Wheel to confirm the month. The day will be flashing.

Example display

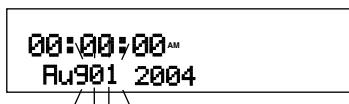

8. With the day flashing turn the Jog Wheel to tab through days.
9. When the day is correct, push and release the Jog Wheel to confirm. The year will be flashing.

Example display

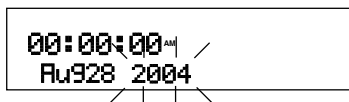

10. With the year flashing turn the Jog Wheel to tab through years. 2003-2099 are selectable.
11. When the year is correct, push and release the Jog Wheel to confirm. The hour will be flashing.

Example display

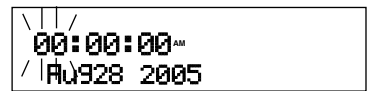

12. With the hour flashing turn the Jog Wheel to tab through hours. AM, PM will change when you pass 12, check that it is correct.
13. When the hour and AM/PM are correct push and release the Jog Wheel to confirm. The minute will be flashing.

Example display

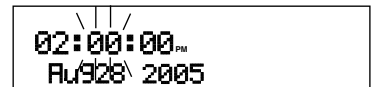

14. With the minute flashing turn the Jog Wheel to tab through minutes (00 through 59).
15. When the minute is correct, push and release the Jog Wheel to confirm. Seconds will be flashing.

Example display



13. With seconds flashing turn the Jog Wheel to tab through seconds (00 through 59).
14. When the second is correct, push and release the Jog Wheel to confirm. Date/Time will be flashing

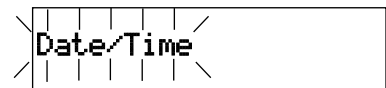

15. If you are done making Menu changes to the Preset, push and release the MENU/STORE button to save your changes,

stored will be displayed briefly



(or push and release the Stop CANCEL button ■ to cancel all changes).

Display returns to stop mode.

### Notes:

- The Date/Time settings will remain for about 5 years if the PMD570 is not plugged in.
- Date/Time setting applies to all three presets.
- If you set any of the three Presets to default, you have to reset the Date and Time.

### How to set or change the Date Form

The date form is the date order month/day/year or day/month/year.

The US default is M/D/Y (month/day/year).

The Europe default is D/M/Y (day/month/year).

1. From stop push and release the MENU/STORE button.
2. Turn the Jog Wheel to select Preset1, 2 or 3.
3. Push and release the Jog Wheel to accept the selected Preset.
4. Turn the Jog Wheel so Date Form is displayed and flashing.

Example display

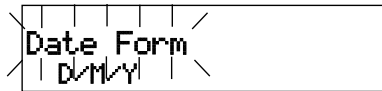

5. While Date Form is flashing, push and release the Jog Wheel. The D/M/Y (or M/D/Y) will be flashing.

Example display



6. Turn the Jog Wheel to toggle between D/M/Y and M/D/Y.
7. When correct, push and release the Jog Wheel. The display returns to Date Form flashing.
8. If you are done making Menu changes to the Preset, push and release the MENU/STORE button to save your changes,

stored will be displayed briefly

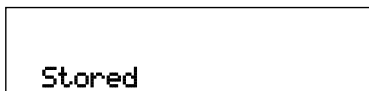

(or push and release the Stop CANCEL button ■ to cancel all changes).

Display returns to stop mode.

**RecFormat**

The PMD570 can record in a variety of compression algorithm, associated bit rate, file format, and recording type (channels recorded) parameters. See explanations and chart below.

First determine the input connection you want to record from; BALANCED IN, ANALOG, or DIGITAL IN. Second set the Preset Menu Input choice to correspond with the connection: Bal.In, Unbal., or Dig-IN.

**RecFormat parameters:**

**Channels**

The recording channel can be stereo (two discrete channels of recording) or mono (one channel of recording). Set to match your inputs.

**Algorithm**

The PMD570 can record using three methods, PCM and two compression algorithms: MP2, and MP3.

**PCM** (Pulse Code Modulation) is uncompressed. These are high quality audio files used in the recording industry. For example, for recording CD quality music.

**MP3** is highly compressed, and creates relatively small files that are commonly used to share files on the internet.

**MP2** is a compressed file format that is commonly used in broadcasting. MP2 audio is a higher quality than MP3. This is especially useful when lower bitrates are used. If you are a news reporter you will probably want to record in Broadcast Wave format (BWF) using MP2 compression.

Marantz Professional's PMDEdit application software and other professional level computer applications are available for computer processing of PCM, MP2 and MP3 files.

**Sampling Frequency**

Sampling frequency is measured in kHz (kilohertz). The sampling frequency is the number of samples of the audio wave(s) per second. For example, the PMD570 can record PCM at 48 kHz that is 48,000 samples per second.

**Bit Rate**

The bit rate for PCM is constant for each sampling frequency. MP2 and MP3 can be recorded at a number of different bit rates.

**File Format**

The file format (3 character computer file extension) can be .wav, .bwf, .mpg or .mp3. Broadcast Wave format, used primarily in the broadcast industry, includes identification codes in the file header.

**Chart of RecFormat Parameters**

The PMD570 parameter menu settings are extensive but limited to plausible combinations.

This table of parameters reflects the menu setting sequence.

Column

1. input
2. channel(s)
3. audio format
4. sampling frequency
5. bit rate
6. file format
7. extension (if BWF chosen in 6)

**1** Bal.In, Unbal. or Dig-In

2	3	4	5	6	7
Stereo	PCM	48	--- (1536)	.wav/ .bwf	.wav/ .bwf
		44.1	--- (1412)		
		32	--- (1024)		
		24	--- (768)		
		22.05	--- (704)		
	MP2	48	384,256,192,128,96,64	.mpg/ .bwf	.wav/ .bwf
		44.1			
		32			
	MP3	48	320,256,160,128,80,64	.mp3/ .bwf	.wav/ .bwf
		44.1			
		32			
		24	320,256,160,128,80,64	.mp3	
		22.05			
	16				
	Mono	PCM	48	--- (768)	.wav/ .bwf
44.1			--- (705.6)		
32			--- (512)		
24			--- (384)		
22.05			--- (352)		
MP2		48	192,128,96,64,48,32	.mpg/ .bwf	.wav/ .bwf
		44.1			
		32			
MP3		48	160,128,80,64,40,32	.mp3/ .bwf	.wav/ .bwf
		44.1			
		32			
		24	160,128,80,64,40,32	.mp3	
		22.05			
16					



## How to set or change the RecFormat parameters

This table of RecFormat parameters reflects the menu setting procedure of those parameters.

### 1 Bal.In, Unbal. or Dig-In

2	3	4	5	6	7		
Stereo	PCM	48	--- (1536)	.wav/ .bwf	.wav/ .bwf		
		44.1	--- (1412)				
		32	--- (1024)				
		24	--- (768)				
		22.05	--- (704)				
		16	--- (512)				
	MP2	48	384,256,192,128,96,64	.mpg/ .bwf	.wav/ .bwf		
		44.1					
		32					
		24					
		22.05					
		16					
	MP3	48	320,256,160,128,80,64	.mp3/ .bwf	.wav/ .bwf		
		44.1					
		32					
24							
22.05		320,256,160,128,80,64				.mp3	
16							
Mono	PCM	48	--- (768)	.wav/ .bwf	.wav/ .bwf		
		44.1	--- (705.6)				
		32	--- (512)				
		24	--- (384)				
		22.05	--- (352)				
		16	--- (256)				
	MP2	48	192,128,96,64,48,32	.mpg/ .bwf	.wav/ .bwf		
		44.1					
		32					
		24					
		22.05				160,128,80,64,40,32	.mp3
		16					
	MP3	48	160,128,80,64,40,32	.mp3/ .bwf	.wav/ .bwf		
		44.1					
		32					
24							
22.05		160,128,80,64,40,32				.mp3	
16							

First choose Bal.In or Unbal. (Col. 1) from the Input menu choice (see page 25.)

1. From stop push and release the MENU/STORE button.
2. Turn the Jog Wheel to select Preset1, 2 or 3.
3. Push and release the Jog Wheel to accept the selected Preset.
4. Turn the Jog Wheel so RecFormat is displayed and flashing.

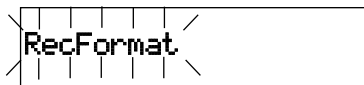

5. While RecFormat is flashing push and release the Jog Wheel. Channel information, Stereo or

Mono, will be displayed and flashing. (Col. 2)

Example display



6. While the channel information is flashing turn the Jog Wheel to toggle between stereo and mono. Push and release the Jog Wheel when correct.

Example display shows change to mono.

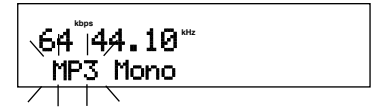

Note:

The bitrate changed when the channel changed to Mono.

The stereo bitrate was 128 kbps, consisting of two channels at 64 kbps each. The change to mono thus changed the bitrate to 64 kbps.

7. The compression algorithm will be flashing (Col. 3). While the compression algorithm is flashing turn the Jog Wheel to tab between MP3, PCM, and MP2. Push and release the Jog Wheel when correct.

Example display shows no change.



8. The sampling frequency (kHz) will be flashing (Col. 4).

While the sampling frequency is flashing turn the Jog Wheel to tab through available sampling frequency choices (available frequencies depend on channel, and compression algorithm choice). Push and release the Jog Wheel when correct.

Example display shows change to 48.00 kHz.

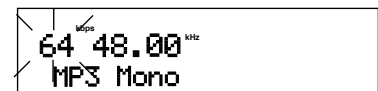

9. The bitrate (kbps) will be flashing (Col. 5). While the bitrate is flashing turn the Jog Wheel to tab through available bitrate choices.

Example display shows change to 32 kbps.



Push and release the Jog Wheel when correct.

continues



## How to set or change the RecFormat parameters continued

### 1 Bal.In, Unbal. or Dig-In

2	3	4	5	6	7
Stereo	PCM	48	--- (1536)	.wav/ .bwf	.wav/ .bwf
		44.1	--- (1412)		
		32	--- (1024)		
		24	--- (768)		
		22.05	--- (704)		
		16	--- (512)		
	MP2	48	384,256,192,128,96,64	.mpg/ .bwf	.wav/ .bwf
		44.1			
		32			
		24			
		22.05			
		16			
	MP3	48	320,256,160,128,80,64	.mp3/ .bwf	.wav/ .bwf
		44.1			
		32			
24					
22.05					
16					
Mono	PCM	48	--- (768)	.wav/ .bwf	.wav/ .bwf
		44.1	--- (705.6)		
		32	--- (512)		
		24	--- (384)		
		22.05	--- (352)		
		16	--- (256)		
	MP2	48	192,128,96,64,48,32	.mpg/ .bwf	.wav/ .bwf
		44.1			
		32			
		24			
		22.05			
		16			
	MP3	48	160,128,80,64,40,32	.mp3/ .bwf	.wav/ .bwf
		44.1			
		32			
24					
22.05					
16					

Pushing and releasing the Jog Wheel with bwf selected switches to the column 7 default (wav). Turn the Jog Wheel to switch between .wav and .bwf.

Example display

```

File wav
MP3/Mono
  
```

#### Note:

Choosing wav in column 6 results in a WAV format file with a .wav extension. Choosing wav in column 7 results in a BWF format file with a .wav extension.

11. When correct, push and release the Jog Wheel. The display returns to RecFormat flashing.

```

RecFormat
  
```

12. If you are done making Menu changes to the Preset, push and release the MENU/STORE button to save your changes,

Stored is displayed briefly.

```

Stored
  
```

- (or push and release the Stop CANCEL button ■ to cancel all changes).

10. The file extension for the chosen file format will be flashing (Col. 6). While the file extension is flashing turn the Jog Wheel to tab through available file format choices.

Example display

```

File MP3
MP3/Mono
  
```

#### Note:

If BWF is chosen an additional step (Col. 7) permits choosing between a .bwf or .wav file extension. Default is .wav.

Example display with bwf selected at Col. 6.

```

File bfw
MP3/Mono
  
```

## Pre Record

When PreRecord is on and the PMD570 is in record pause, it 'listens to' the selected audio input(s) and continuously buffers 2 seconds of audio. When recording begins the 2 second pre record buffer is written at the beginning of the new track. The 2 seconds give you time to precisely start recording without missing the first seconds of audio.

Default setting is Off.

1. From stop push and release the MENU/STORE button.
2. Turn the Jog Wheel to select Preset1, 2 or 3.
3. Push and release the Jog Wheel to accept the selected Preset.
4. Turn the Jog Wheel so PreRecord is displayed and flashing.

Example display

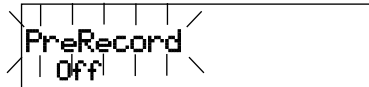

5. While PreRecord is flashing, push and release the Jog Wheel. The On or Off will be flashing.
6. Turn the Jog Wheel to toggle between On and Off.

Example display

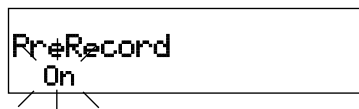

7. When correct, push and release the Jog Wheel. The display returns to PreRecord flashing.
8. If you are done making Menu changes to the Preset, push and release the MENU/STORE button to save your changes,

stored will be displayed briefly



(or push and release the Stop CANCEL button ■ to cancel all changes).

Display returns to stop mode.

## Auto Mark

The Auto Mark Menu item turns the automatic EDL mark feature on or off. See page 19 to manually add EDL marks.

When On, during recording, a record pause (pushing and releasing the Play/Pause button ►||, then pushing and releasing the Record button ● to resume recording) automatically adds an EDL mark.

When Off, a record pause does not add an EDL mark to the track.

Default setting is Off.

1. From stop push and release the MENU/STORE button.
2. Turn the Jog Wheel to select Preset1, 2 or 3.
3. Push and release the Jog Wheel to accept the selected Preset.
4. Turn the Jog Wheel so Auto Mark is displayed and flashing.

Example display

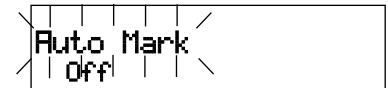

5. While Auto Mark is flashing, push and release the Jog Wheel. The On or Off will be flashing.
6. Turn the Jog Wheel to toggle between On and Off.

Example display



7. When correct, push and release the Jog Wheel. The display returns to Auto Mark flashing.
8. If you are done making Menu changes to the Preset, push and release the MENU/STORE button to save your changes,

stored will be displayed briefly



(or push and release the Stop CANCEL button ■ to cancel all changes).

Display returns to stop mode.

## Manual TR

When Manual track incrementing is On, during recording push and release the Record button ● to increment the track. A new track is created at that point. A slight break can be heard during playback. See Seamless Play, page 33, to eliminate the audio break during playback.

When Manual track incrementing is Off, pushing and releasing the Record button ● during recording does nothing.

Default setting is On.

1. From stop push and release the MENU/STORE button.
2. Turn the Jog Wheel to select Preset1, 2 or 3.
3. Push and release the Jog Wheel to accept the selected Preset.
4. Turn the Jog Wheel so Manual TR is displayed and flashing.

Example display

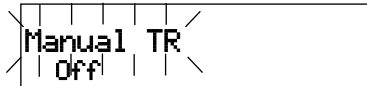

5. While Manual TR is flashing, push and release the Jog Wheel. The On or Off will be flashing.
6. Turn the Jog Wheel to toggle between On and Off.

Example display

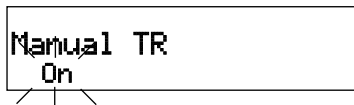

7. When correct, push and release the Jog Wheel. The display returns to Manual TR flashing.

8. If you are done making Menu changes to the Preset, push and release the MENU/STORE button to save your changes,

stored will be displayed briefly

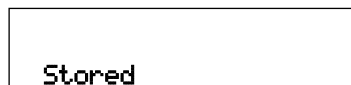

(or push and release the Stop CANCEL button ■ to cancel all changes).

Display returns to stop mode.

## Auto Trk

With Auto Trk (Automatic Track incrementing) On, new track is begun automatically at specified intervals of recording time.

Automatic Tracks are silent. Playback across an Automatic Track does not produce any sound.

Automatic Track can be set to increment every 1, 5, 10, 15, or 30 minutes or every 1, 2, 6, 8, 12, or 24 hours.

### Minute track

Automatic Tracks make finding a particular point in a recording easier. For example if a new track is begun every minute. During playback the Minute Tracks make finding a particular passage easier because of the relationship between track numbers and time. During playback you can select track 3 to play approximately the 3rd minute of recording. To go directly to the beginning of the 10th minute select track 10, etc.

Track #	Recording time minutes:seconds
1	0:00 - 1:00
2	1:01 - 2:00
3	2:01 - 3:00
.	.
.	.
.	.

Note:

If you intend to transfer your PMD570 audio recording to a CD the Auto Track function can make the CD easily navigable without requiring any post production to divide files into tracks.

Default setting is Off.

1. From stop push and release the MENU/STORE button.
2. Turn the Jog Wheel to select Preset1, 2 or 3.
3. Push and release the Jog Wheel to accept the selected Preset.
4. Turn the Jog Wheel so Auto TRK is displayed and flashing.

Example display

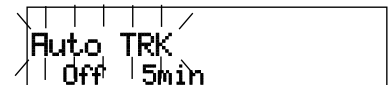

5. While Auto Trk is flashing, push and release the Jog Wheel. The On or Off will be flashing.
6. Turn the Jog Wheel to toggle between On and Off.

Example display



7. When correct, push and release the Jog Wheel. The display switches to time interval flashing.

Example display

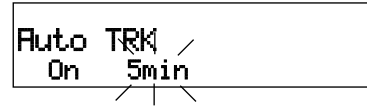

8. Turn the Jog Wheel to tab through the time interval choices (1, 5, 10, 15, or 30 minutes, or 1, 2, 6, 8, 12, or 24 hours). When correct, push and release the Jog Wheel. The display returns to Auto TRK flashing.

Example display

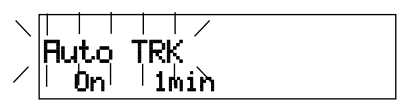

9. If you are done making Menu changes to the Preset, push and release the MENU/STORE button to save your changes,

stored will be displayed briefly



(or push and release the Stop CANCEL button ■ to cancel all changes).

Display returns to stop mode.

### SeamlsPly (Seamless Play)

When Seamless Play is On, during playback in Play Modes Normal and Repeat All, multiple tracks\* will be played back in sequence without any break (space) between the tracks.

When Seamless Play is Off, during playback multiple tracks will be played back in sequence with breaks (brief periods of silence) between the tracks.

\*Tracks created manually during a continuous recording.

Default setting is Off.

1. From stop push and release the MENU/STORE button.
2. Turn the Jog Wheel to select Preset1, 2 or 3.
3. Push and release the Jog Wheel to accept the selected Preset.
4. Turn the Jog Wheel so SeamlsPly is displayed and flashing.

Example display

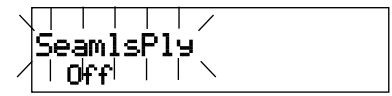

5. While SeamlsPly is flashing, push and release the Jog Wheel. The On or Off will be flashing.
6. Turn the Jog Wheel to toggle between On and Off.

Example display

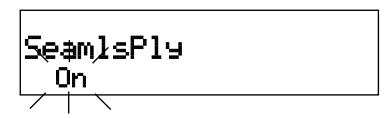

7. When correct, push and release the Jog Wheel. The display returns to SeamlsPly flashing.

8. If you are done making Menu changes to the Preset, push and release the MENU/STORE button to save your changes,

stored will be displayed briefly

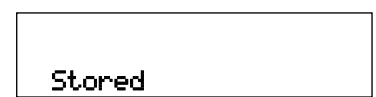

(or push and release the Stop CANCEL button ■ to cancel all changes).

Display returns to stop mode.

## SilentSkp (Silent Skip)

Silent skip automatically pauses recording when there is a period of silence and resumes recording when sound resumes. Sometimes this feature is referred to as voice activated recording. Silent Skip looks for sound below a preset level for a preset period of time. When that occurs the PMD570 switches to record pause. When a signal of about -30 dB is input recording resumes.

The SilentSkp Menu settings permit:

- turning Silent Skip On or Off
- adjusting the silent time period in one second intervals from 1 to 5 seconds, and
- adjusting the margin sound level that defines silence in -5 dB increments from -20 to -60 dB.

When the Auto Mark menu choice is at On resumption of recording after a record pause by Silent Skip adds an EDL mark.

Default settings are Off, 3 seconds, and -40 dB.

1. From stop push and release the MENU/STORE button.
2. Turn the Jog Wheel to select Preset1, 2 or 3.
3. Push and release the Jog Wheel to accept the selected Preset.
4. Turn the Jog Wheel so SilentSkp is displayed and flashing.

Example display



5. While SilentSkp is flashing, push and release the Jog Wheel. The On or Off will be flashing.
  6. Turn the Jog Wheel to toggle between On and Off.
- Example display
- 
- A rectangular display box showing 'SilentSkp' on the top line, 'On 03sec' on the second line, and '40' with a small '-dB' symbol on the right side of the bottom line.
7. When correct, push and release the Jog Wheel. The display switches to time interval flashing.

Example display



8. Turn the Jog Wheel to tab through the silent time interval choices (1 - 5 seconds).

When correct, push and release the Jog Wheel. The display switches to -dB flashing.

Example display



9. Turn the Jog Wheel to tab through the margin sound level choices (-20 through -60 dB in 5 dB units). When correct, push and release the Jog Wheel. The display returns to SilentSkp flashing.



10. If you are done making Menu changes to the Preset, push and release the MENU/STORE button to save your changes,

stored will be displayed briefly



(or push and release the Stop CANCEL button ■ to cancel all changes).

Display returns to stop mode.

### Note:

When Silent Skip is On S.SKIP appears in the display during stop, record and playback.

Example display



S.SKIP

**Auto Cue**

Auto Cue skips the silence at the beginning of an audio track and pauses playback at the point where the audio begins (sound is loud enough for long enough). You can adjust how loud (how many dB) and how long (milliseconds) the audio has to be before playback is cued.

The Auto Cue Menu settings permit:

- turning Auto Cue On or Off
- adjusting the millisecond period in 5 millisecond intervals from 5 to 95 milliseconds, and
- adjusting the margin sound level that defines where audio begins in -5 dB increments from -20 to -60 dB.

If Normal Play Mode is selected (see Play Mode), when the end of the track is reached Auto Cue pauses playback cued to the sound of the next track.

Default settings are Off, 20 milliseconds, and -40 dB.

1. From stop push and release the MENU/STORE button.
2. Turn the Jog Wheel to select Preset1, 2 or 3.
3. Push and release the Jog Wheel to accept the selected Preset.
4. Turn the Jog Wheel so Auto Cue is displayed and flashing.

Example display



5. While Auto Cue is flashing, push and release the Jog Wheel. The On or Off will be flashing.
6. Turn the Jog Wheel to toggle between On and Off.

Example display



7. When correct, push and release the Jog Wheel. The display switches to milliseconds flashing.

Example display



8. Turn the Jog Wheel to tab through milliseconds (05 - 95 milliseconds).

When correct, push and release the Jog Wheel. The display switches to -dB flashing.

Example display



9. Turn the Jog Wheel to tab through the margin sound level choices (-20 through -60 dB in 5 dB units). When correct, push and release the Jog Wheel. The display returns to Auto Cue flashing.



10. If you are done making Menu changes to the Preset, push and release the MENU/STORE button to save your changes,

stored will be displayed briefly



(or push and release the Stop CANCEL button ■ to cancel all changes).

Display returns to stop mode.

**Note:**

When Auto Cue is turned On, the PMD570 will continue to search until audio of a significant level is located within the playing track - where the unit will then enter Play/Pause. To end this process, either press stop or turn Auto Cue off in the menu.

### Play Mode

Play Mode lets you choose what happens when the end of a track is reached during playback.

#### Normal

When playback reaches the end of a track it automatically begins the next track until all tracks on the CF card have been played. After the last track on the CF card, playback stops. The PMD570 returns to stop mode.

#### Repeat All

During playback all tracks are repeated. Same as Normal except when playback reaches the end of the last track it automatically starts playback from the beginning of the first track.

#### Repeat TRK

When playback reaches the end of the track it automatically starts playing again at the beginning of the same track.

#### Single

When playback reaches the end of the track it automatically pauses at the beginning of the next track.

Note:

For other methods of repeat playback see How to A-B repeat on page 19 and/or How to Edit EDL marks on page 45.

Default setting is Normal.

1. From stop push and release the MENU/STORE button.
2. Turn the Jog Wheel to select Preset1, 2 or 3.
3. Push and release the Jog Wheel to accept the selected Preset.
4. Turn the Jog Wheel so Play Mode is displayed and flashing.

Example display



5. While Play Mode is flashing, push and release the Jog Wheel. The currently selected mode will be flashing.

6. Turn the Jog Wheel to tab through the Play Mode choices: Normal, Repeat All, Repeat TRK and Single.

Example display



7. When the desired Play Mode is displayed, push and release the Jog Wheel. The display returns to Play Mode flashing.
8. If you are done making Menu changes to the Preset, push and release the MENU/STORE button to save your changes,

stored will be displayed briefly



(or push and release the Stop CANCEL button ■ to cancel all changes).

Display returns to stop mode.



## EDL Play

The EDL Play menu turns EDL Play On or Off.

### Off

PMD570 playback does not respond to EDL mark instructions.

### On

PMD570 follows EDL mark instructions regarding playback order, skipping sections of recording on the memory card, or repeating (EDL A-B repeat) a section of recording on the memory card. See page 45.

### Note:

If EDL Play is at On and there are no EDL marks on the CF card playback is not available. Switch to Off for playback.

Default setting is Off.

1. From stop push and release the MENU/STORE button.
2. Turn the Jog Wheel to select Preset1, 2 or 3.
3. Push and release the Jog Wheel to accept the selected Preset.
4. Turn the Jog Wheel so EDL Play is displayed and flashing.

Example display

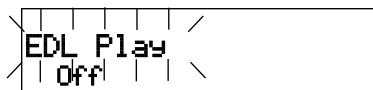

5. While EDL Play is flashing, push and release the Jog Wheel. The On or Off will be flashing.
6. Turn the Jog Wheel to toggle between On and Off.

Example display



7. When correct, push and release the Jog Wheel. The display returns to EDL Play flashing.

8. If you are done making Menu changes to the Preset, push and release the MENU/STORE button to save your changes,

stored will be displayed briefly



(or push and release the Stop CANCEL button ■ to cancel all changes).

Display returns to stop mode.

Example display during EDL play.



## Remote

The Remote Menu setting is for a wired remote (not supplied) plugged into the REMOTE1 Phone jack. (The optional remote Marantz model RC600 that plugs into the REMOTE2 TRRS connector is plug-and-play and has no menu choices.)

There are four remote modes:

- **StartPause**  
Start or pause during recording or playback. If Auto Mark is ON and EDL mark is added when recording resumes.
- **StrtPausTR**  
Start or pause during recording or playback. After a record pause, recording continues on the next track.
- **EDL Mark**  
During record or playback switch remote to on to add an EDL mark.
- **Manual TRK**  
During recording, switch remote to on to increment the track. A new track is created at that point. There is no break in recording.

Default setting is StartPause.

1. From stop push and release the MENU/STORE button.
2. Turn the Jog Wheel to select Preset1, 2 or 3.
3. Push and release the Jog Wheel to accept the selected Preset.

4. Turn the Jog Wheel so Remote is displayed and flashing.

Example display



5. While Remote is flashing, push and release the Jog Wheel. The current remote setting will be flashing.
6. Turn the Jog Wheel to tab through the remote

settings: StartPause, StrtPausTR, EDL Mark, and Manual TRK.

Example display



- 7. When correct, push and release the Jog Wheel. The display returns to Remote flashing.
- 8. If you are done making Menu changes to the Preset, push and release the MENU/STORE button to save your changes,

stored will be displayed briefly



(or push and release the Stop CANCEL button ■ to cancel all changes).

Display returns to stop mode.

### ID1Dscrpt, ID2Origin, ID3OrRef (Broadcast Wave ID numbers)

Broadcast Wave Format (.bwf/.wav) has three identification numbers in the header (Extension Chunk): Description, Originator, and Originator Reference. For example, if the IDs are used for a broadcast station ID1 could be the identifier of the station, ID2 could be used for the department code, and ID3 for the badge number of the reporter.

Default is all ID numbers at 000000.

- 1. From stop push and release the MENU/STORE button.
- 2. Turn the Jog Wheel to select Preset1, 2 or 3.
- 3. Push and release the Jog Wheel to accept the selected Preset.
- 4. Turn the Jog Wheel so ID1Dscrpt, ID2Origin, or ID3OrRef is displayed and flashing.

Example display



- 5. While the ID# is flashing, push and release the Jog Wheel. The first number of the ID will be flashing.

Example display



- 6. Turn the Jog Wheel to tab through numbers (and alphabetic characters).

Example display



- 7. When correct, push and release the Jog Wheel. The number position will be flashing.

Example display



Repeat steps 6 and 7 until all ID numbers are correct.

- 8. After the last number, push and release the Jog Wheel. The display returns to the ID# flashing.
- 9. If you are done making Menu changes to the Preset, push and release the MENU/STORE button to save your changes,

stored will be displayed briefly



(or push and release the Stop CANCEL button ■ to cancel all changes).

Display returns to stop mode.

**Default (Menu Default)**

The Default menu choice resets all Menu (not Edit Menu) items in the Preset to their default values. This is handy if you are setting up a new Preset configuration because you don't have to check all the settings, you know they are at the default.

Note:

Putting any Preset to its default also resets the main clock.

AM/PM will be flashing to remind you that the Date and Time are no longer current. See page 26 for how to set the Date and Time.

Defaults are listed for each menu item.

Notes:

- US defaults are used for illustration.

1. From stop push and release the MENU/STORE button.

Preset1, Preset2 or Preset3 flashing.

Example display

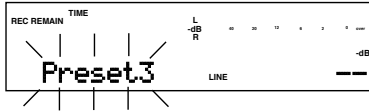

2. Turn the Jog Wheel to select Preset1, 2 or 3.
3. Push and release the Jog Wheel to accept the selected Preset. A Menu item will be flashing.

Example display

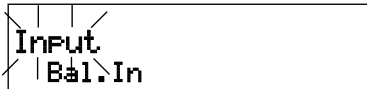

4. Turn the Jog Wheel so Default is flashing.

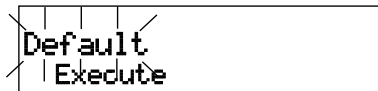

5. Push and release the Jog Wheel. Execute flashing.



6. If you are sure you want to set the Preset to its default push and release the Jog Wheel (or push and release the Stop CANCEL button ■ to cancel).

EXECUTING will be displayed for a couple of seconds while the default is being written.



The display will briefly display Done.



Display returns to stop mode.

Example display

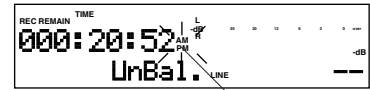

AM  
PM

## Renumber (tracks)

If you have erased tracks from the CF card it can be easier to locate recordings if the tracks are renumbered.

1. Select the Renumber EDIT Menu choice:

While in stop, push and hold the **SHIFT** button while you push and release the MENU/STORE button.

Renumber is displayed and flashing.

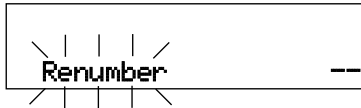

2. While Renumber is flashing (5 seconds) push and release the Jog Wheel. Renum OK? will be displayed and flashing.

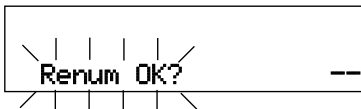

3. While Renum OK? is flashing push and release the Jog Wheel.

EXECUTING will be displayed and the percentage executing will increase to 100%.

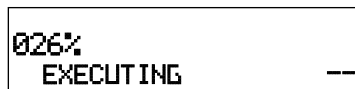

100% Done will be displayed momentarily



The PMD570 and the display will return to stop mode.

\*To cancel push and release the Stop/CANCEL button ■.

## TrkERASE

TrkERASE lets you erase a chosen track. Identify the track number you want to erase.

1. Select the TrkERASE EDIT Menu choice:

While in stop, push and hold the **SHIFT** button while you push and release the MENU/STORE button. Renumber will appear (flashing) in the display.

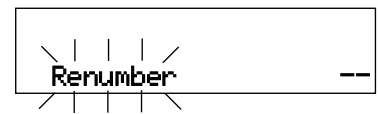

2. While Renumber is flashing (for about 3 seconds) turn the Jog Wheel until TrkERASE is flashing.



3. Push and release the Jog Wheel while TrkERASE is flashing (for about 5 seconds). The display switches to TRACK 001 flashing.

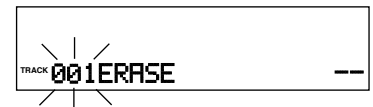

4. Turn the Jog Wheel so the track number you want to erase is flashing.

Example display

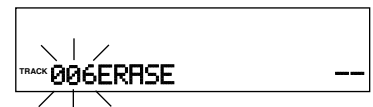

5. Push and release the Jog Wheel\*.

EXECUTING will be displayed momentarily.

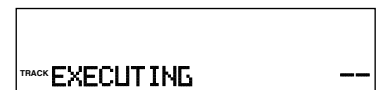

Display returns to step 3 so you can erase another track.



Push and release the Stop/CANCEL button ■ to exit.

### Note:

Tracks are not automatically renumbered. For example if you have 5 tracks and erase track 3, the tracks will then be 1, 2, 4, and 5.

The recording time (file space on the CF card) used by the erased track is available for recording.

\*To cancel, push and release the Stop/CANCEL button ■.

## TrkMkERASE

TrkMkERASE lets you erase all EDL marks of the selected track.

1. Select the TrkMkERASE Menu choice:

While in stop, push and hold the **SHIFT** button while you push and release the MENU/STORE button. Renumber will appear (flashing) in the display.

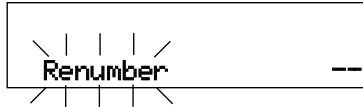

2. While Renumber is flashing (for about 3 seconds) turn the Jog Wheel until TrkMkERASE is flashing.



3. Push and release the Jog Wheel while TrkMKERASE is flashing (for about 5 seconds). The display switches to MARK 001 flashing.



4. Turn the Jog Wheel so the track number you want to erase the marks from is flashing.

Example display



5. Push and release the Jog Wheel\*.

EXECUTING will be displayed momentarily.



The display returns to step 3 so you can erase another mark.



Push and release the Stop/CANCEL button **■** to exit.

### Note:

EDL marks will automatically be renumbered.

\*To cancel, push and release the Stop/CANCEL button **■**.

## AllMkERASE

AllMkERASE erases all EDL marks on the CF card.

1. Select the AllMkERASE Edit Menu choice:

While in stop, push and hold the **SHIFT** button while you push and release the MENU/STORE button. Renumber will appear (flashing) in the display.

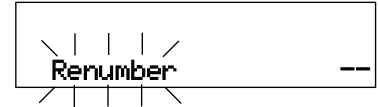

2. While Edit Menu is flashing (for about 3 seconds) turn the Jog Wheel until AllMkERASE is displayed and flashing.

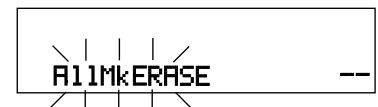

3. While AllMkERASE is flashing (5 seconds) press and release the Jog Wheel. AllMkErOK? will be flashing. The display asks you to confirm that you want to erase all EDL Marks on the CF card.

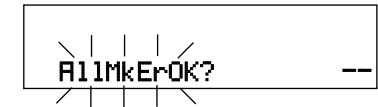

4. While AllMkErOK? is flashing press and release the Jog Wheel to confirm. (Or press and release the Stop/CANCEL button **■** to cancel.) EXECUTING will be displayed momentarily.

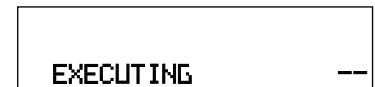

Done will be displayed momentarily.



The PMD570 and the display will return to stop mode.

## FORMAT (CF card)

Formatting a CF card erases all audio files on the card and prepares it for use in the PMD570.

The CF card formats used by the PMD570 are Windows compatible. You can copy audio files using a Windows compatible computer\* that can read a CF card or be connected via the I/O port.

\*Or a Macintosh computer that can recognize Windows compatible removable drives.

### Notes:

CF cards with less than 2 GB capacity are automatically formatted FAT16 (FAT = File Allocation Table).

CF cards with 2 - 8 GB capacity are automatically formatted FAT32.

The maximum CF card that can be formatted in the PMD570 is 8 GB. If larger cards are used please format in your computer.

### To FORMAT a CF card:

1. Select the FORMAT Edit Menu choice:

While in stop, push and hold the **SHIFT** button while you push and release the MENU/STORE button. Renumber will appear (flashing) in the display.

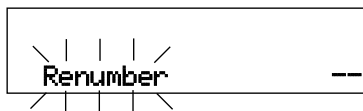

2. While Renumber is flashing (for about 3 seconds) turn the Jog Wheel until FORMAT is flashing.



3. Push and release the Jog Wheel while FORMAT is flashing (for about 5 seconds). The display switches to FORMAT OK? flashing.

FORMAT OK?  
flashing in the  
display.

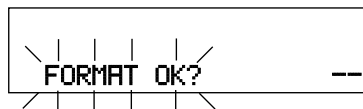

The display asks you to confirm that you want to format the CF card. Formatting the CF card will erase all recordings on the card.

4. While FORMAT OK? is flashing press and release the Jog Wheel to confirm. (Or press and release the STOP button **■** to cancel.)

EXECUTING will be displayed and progress to 100%.

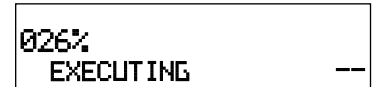

Done will be displayed momentarily.

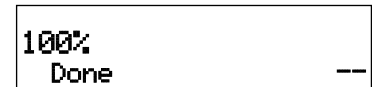

The PMD570 returns to stop mode.  
BlankCard will be displayed.





## I/O port

The CF card in the PMD570 is a Windows formatted PC compatible CF card. The CF card can be removed from the PMD570 and read by a computer with a compatible CF card slot, or, using an I/O cable connection between the PMD570 I/O jack and your computer's I/O port the CF card can remain in the PMD570 and appear as a drive on your computer.

## How to connect via the I/O port

1. Connect a cable to the PMD570 I/O jack and your computer's I/O port.

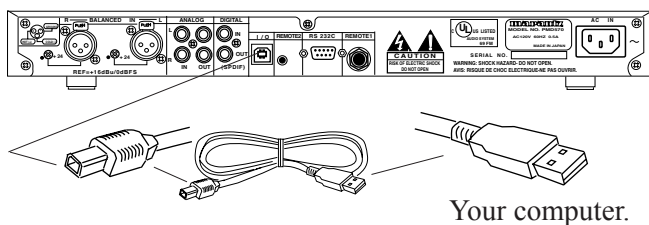

2. Select I/O Online:

From power off, push and hold the MENU/STORE button while you power on by pushing and releasing the POWER ON/OFF button.

I/O Online is displayed



The PMD570 cannot be used while Online.

Power off and back on to resume recording or playback on the PMD570.

While Online the CF card in the PMD570 appears as a removable device on your computer. The audio files are in a folder that is named MPGLANG1.

**CAUTION:** Only copy audio files (tracks) to other volumes. Do not modify or delete the EDL file. If the EDL file is missing or damaged PMD570 will not be able to recognize EDL marks.

Do not remove a CF card during "I/O Online" mode. Data and the CF card can be damaged.

See the enclosed CD-ROM for demo PMDEdit software for computer audio file manipulation.

PMDEdit is a full featured software suite designed for Marantz Professional digital recorders available for purchase at [www.d-mpro.com](http://www.d-mpro.com).

What will appear on your computer is a file titled PMD670.EDL\* and a folder (directory) titled MPGLANG1. Files within the MPGLANG1 folder are numbered from 1001 through the number of tracks recorded to a maximum of 1999. The file extension will be .mp3, .wav, .bwf or .mpg depending on the RecFormat parameters that were set for the recording.

\*PMD670 is used to insure compatibility between PMD670 and PMD570 PMDEdit operations.

## Diagram of file structure (assuming .mp3 files).

Changes made to file names or file structure made on your computer will prevent file recognition and therefore playback in the PMD570.

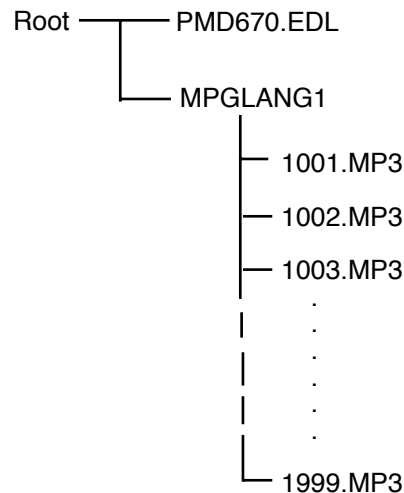

## EDL marks

EDL\* (Edit Decision List) marks help you locate specific points in the recording.

During regular playback EDL marks are silent.

\*The EDL marking system is proprietary to Marantz Professional solid state recorders.

EDL marks can be created during recording manually or automatically. EDL marks can also be added during playback or play pause at any time.

- During stop or play pause you can search for EDL marks by pushing and holding **SHIFT** and turning the Jog Wheel.
- You can change an EDL mark into a skip mark or an A-B repeating point. That lets you create custom playback sequences which include skipping audio between EDL marks or repeating audio between EDL marks. See How to Edit EDL marks on page 45.
- Up to 255 EDL marks can be added to a CF card. EDL marks are numbered consecutively starting at one.
- During recording you can manually add an EDL mark by pressing and holding the **SHIFT** button while pressing and releasing the **MARK** button.
- PMDEdit computer software, is specifically designed for the PMD570 and PMD670. Marantz Professional's PMDEdit application software recognizes EDL marks generated by the PMD570. This is especially useful for editing audio files on your PC. For more information visit [www.d-mpro.com](http://www.d-mpro.com).

EDL marks are initially entered as 'Point' marks. An EDL mark can also be a Skip mark, Loop\_A mark, or Loop\_B mark.

## Skip marks

When EDL Play is at On, playback segments that begin with a Skip mark are skipped. Although the skipped segment remains on the CF card it plays back as if it has been erased.

## Loop marks

When EDL Play is at On, when there is a Loop\_A and a Loop\_B mark on the CF card, playback repeats between the A and B marks.

## Locating EDL Marks

From stop or play pause push and hold the **SHIFT** button while you turn the Jog Wheel to scroll through the EDL marks on the CF card.

### Note:

If you push and hold the **SHIFT** button and turn the Jog Wheel during playback, the PMD570 automatically switches to play pause to scroll through the EDL marks.

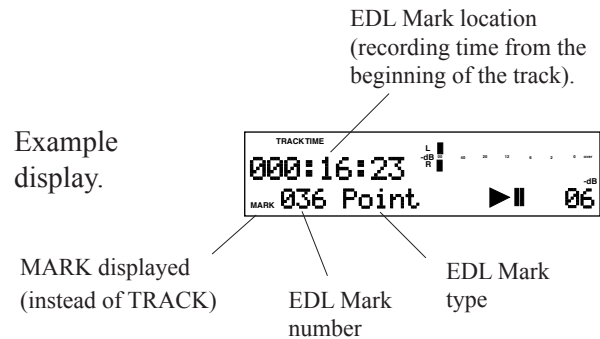

## EDL marks and the beginning of a Track

EDL marks are not automatically placed at the beginning of tracks. If you want your custom playback sequence to include track beginning points add EDL Marks to coincide with track beginning points by:

- a. Start playback by pressing and releasing the Play/Pause button ►/|| and then pause playback by pressing and releasing the Play/Pause button ►/|| again.
- b. Push and release Track jump forward ►► or Track jump reverse ◀◀ until the desired track number is displayed and TRACK TIME is 000:00:00 .
- c. Push and hold **SHIFT** while you push and release the **MARK** button.

## Custom playback sequences

EDL Marks are numbered consecutively from 001 and automatically renumbered when an EDL Mark is added or erased. Playback is also consecutive from the point that playback begins.

EDL Mark custom playback can:

Skip playback from the beginning of a 'Skip' EDL Mark to the beginning of the next EDL Mark.

A-B loop from a 'Loop\_A' EDL Mark to a 'Loop\_B' EDL Mark.

## How to Edit EDL marks:

All EDL marks are initially entered as 'Point' marks.

From stop or play pause, push and hold the **SHIFT** button while you turn the Jog Wheel to tab through the EDL marks.

Example display

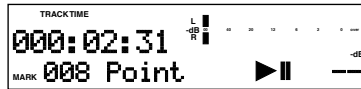

When the EDL mark to be edited is displayed release the **SHIFT** button and immediately push and release the Jog Wheel. The current EDL Mark type will be flashing.

Example display

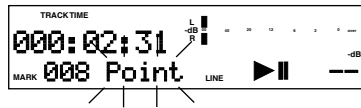

Turn the Jog Wheel to tab through the EDL Mark types: Point, Skip, Loop\_A, Loop\_B, and Erase.

Example display

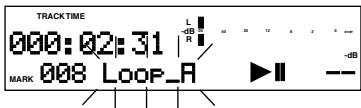

When the type you want to change the EDL mark to is flashing press and release the Jog Wheel. TOC Write will be displayed briefly

Example display

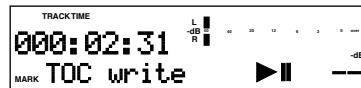

and the PMD670 will return to the EDL selection for 4 seconds,

Example display



then return to stop or play pause.

Example display



## EDL mark types

### Point

Nothing happens during EDL playback.

### Skip

Audio following a Skip EDL mark will be skipped during EDL playback. Playback will skip to the beginning of the next EDL mark.

The skipped EDL audio is not erased. The recording is still on the CF card. The skipped EDL recording will play if EDL Play is at Off. You can change the EDL mark type later.

### Loop\_A and Loop\_B

During EDL playback audio following an EDL Point mark is played, and audio following an EDL Skip mark is skipped. When EDL playback reaches the EDL Loop\_B point, playback switches to the EDL Loop\_A point and continues.

There can only be one EDL A-B loop on a CF card. When a 'Loop\_A' or 'Loop\_B' exists on a CF card and another is created the old mark automatically changes to a 'Skip'.

### Erase

When an EDL mark is erased the remaining EDL marks are automatically renumbered from 1 through the number of EDL marks on the CF card.

### EDL Play

See page 37 for instructions on turning the EDL Play Menu item On or Off.

**OFF:** When the EDL Play is Off PMD570 playback does not respond to EDL mark instructions.

**ON:** When EDL Play is ON PMD570 playback follows EDL mark instructions regarding playback order, skipping sections of recording on the memory card, or repeating a section of recording on the memory card.

Note:

If the EDL Play Menu item is at On and there are no EDL marks on the CF card, playback is not available. Switch the EDL Play Menu item to Off for playback.

## RS-232C Control Windows Application

An RS232 Windows Application for the PMD570 is available for free download (see [www.d-mpro.com](http://www.d-mpro.com) to download). The Application lets you control and setup the PMD570 from your PC.

Connect your Windows compatible computer to the PMD570 via the REMOTE RS-232C connector on the PMD570 to your computer's RS-232C port. Install the software on your computer.

- control all functions of PMD570
- setup/preset menu
- read/write settings to/from PMD570
- save settings as text file,
- convert settings text file to setup/presets of PMD570
- see [www.d-mpro.com](http://www.d-mpro.com) for available setup text files from Marantz Professional

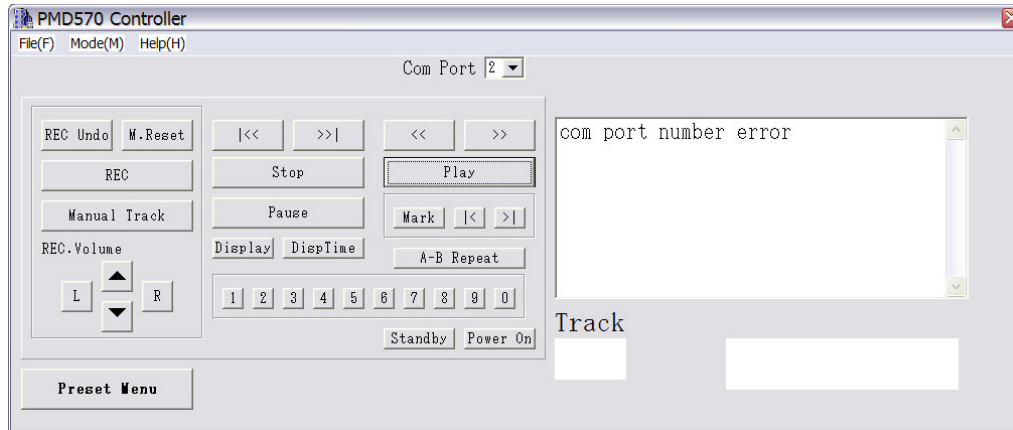

Control screen as it would appear on your computer.

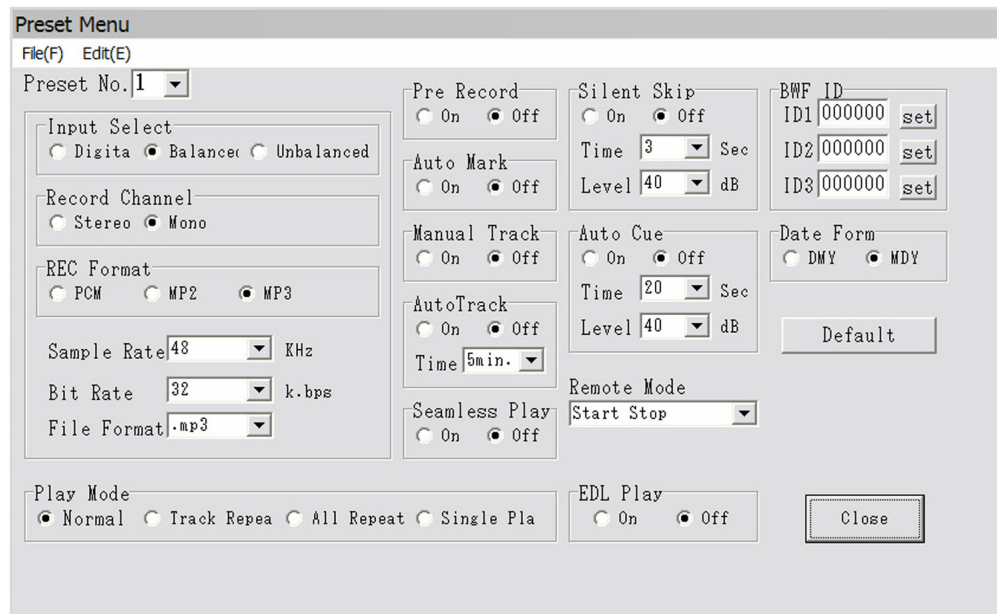

Preset Menu screen as it would appear on your computer (example settings).

### RS-232C control

Connect a male (D-Sub 9 Pin) to female (D-Sub 9 Pin) straight cable for RS-232C external control by host equipment.

- The RS-232C host can control functions of the PMD570 externally
- The PMD570 automatically transmits status data when status is changed.
- The PMD570 will respond to status requests by transmitting the associated status data.

### RS-232C specifications:

#### Connector pin assignment

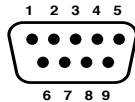

pin	use	PMD570	Typical Host
1	NC	Not Connected	Not Connected
2	TX	Transmit Data	Receive Data
3	RX	Receive Data	Transmit Data
4	NC	Not Connected	Not Connected
5	GND	Ground	Ground
6	NC	Not connected	Not connected
7	RTS	RTS receive	RTS send
8	CTS	CTS send	CTS receive
9	NC	Not Connected	Not Connected

cable connector

D-Sub 9 pin (male)

D-Sub 9 pin (female)

#### Physical specifications

Cable	Straight cable
Baud rate	9600 bps
Data bits	8 bits
Parity bit	None
Stop bit	1 bit
Flow control	CTS/RTS Hardware Flow

#### Flow control and timing

CTS/RTS hardware flow control

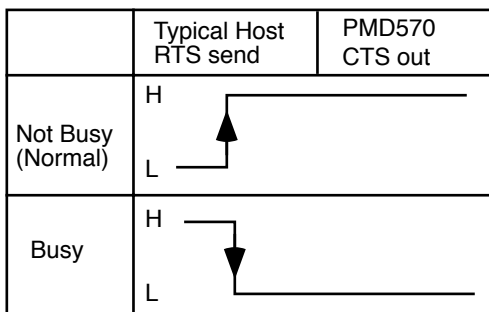

#### Timing chart

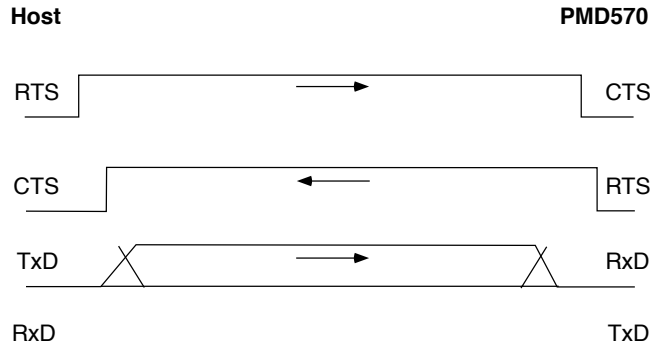

1. The host requests data by setting RTS to L.
2. Upon data request by CTS, the PMD570 responds by setting RTS to H if not busy.
3. The host checks if CTS is H and starts data output on TxD.
4. When data output finishes, the host sets RTS to H.
5. The PMD570 checks if CTS is H and sets RTS to L.

#### Command format

Start character: @  
End character: 0Dh

#### Basic format

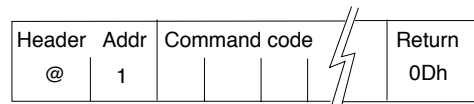

#### Received okay and error codes

OK (data receive successful) (ACK): 06h  
Error (data receive error) (NACK): 15h

Normal Return

Error Return

OK  
06h

ERR  
15h

#### Notes:

The receiving side ignores data received prior to "@". If code data is received without receiving "@", the data receive error code will be returned. The tolerance for send/receive clock error is ±10%. For sending a command, wait more than 20ms after reception of a response (OK, ERR or Status). Reception of 0Dh or timeout is used to determine the end of a command. Timeout occurs 1 second after the reception of the last byte.

## Hand shake flow charts for control commands

Host sends a command that causes a change in PMD570 status.

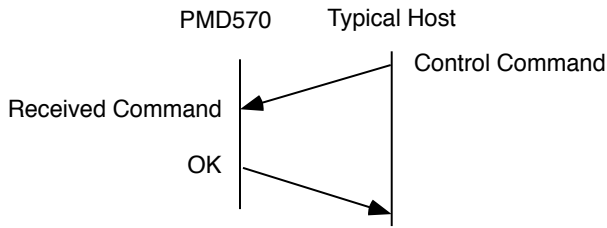

Host sends a command that causes no change in PMD570 status. For example, Host requests Play during Playback.

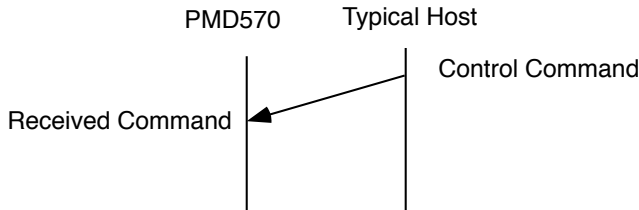

Status Request Commands from the host are received by the PMD570, then the status information code is transmitted to the host.

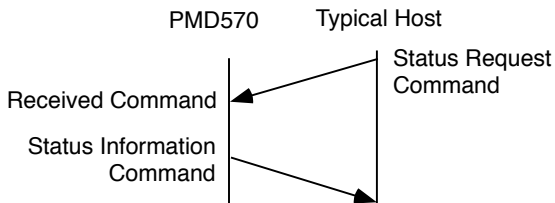

A change in the state of the PMD570 automatically transmits a status information code to the host.

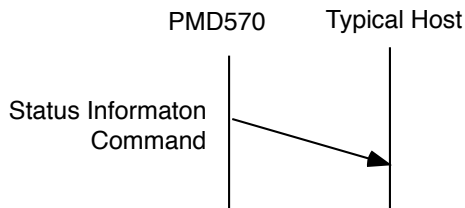

## Control command codes

The control command packets have a data length of 7~10 bytes. ASCII codes from 0x00 to 0x7f are used to receive serial data. At the transmission end, take steps to convert the ASCII codes into HEX data to set the data in the data packets. CR (0x0d) is added as the data packet delimiter.

Example: Control command code for number 5 (ASCII code @02305CR)

@	0	2	3	0	5	CR
0x40	0x30	0x32	0x33	0x30	0x35	0x0d

When transmitting commands consecutively, put more than 100ms blank between commands.

## Status Request and Status Information codes :

The status data packets have a fixed data length of 8 bytes. ASCII codes from 0x00 to 0x7f are used to transmit serial data. For this reason, the ASCII codes are converted into HEX data before the data is set in the data packets and transmitted. CR (0x0d) is added as the data packet delimiter.

Example: Status Information code "Door open" (ASCII code @0DS01CR)

@	0	D	S	0	1	CR
0x40	0x30	0x44	0x53	0x30	0x31	0x0d

## Table of Control command codes

Control Command	Code
0	"@02300" + CR
1	"@02301" + CR
2	"@02302" + CR
3	"@02303" + CR
4	"@02304" + CR
5	"@02305" + CR
6	"@02306" + CR
7	"@02307" + CR
8	"@02308" + CR
9	"@02309" + CR
DISPLAY	"@02311" + CR
Standby	"@02312" + CR
Power ON	"@023PW" + CR
Add EDL mark	"@023121" + CR
Recording Volume +	"@023V+" + CR
Recording Volume -	"@023V-" + CR
Recording Balance Right	"@023BR" + CR
Recording Balance Left	"@023BL" + CR
Track Jump >>I (Next)	"@02332" + CR
Track Jump I<< (Back)	"@02333" + CR
PAUSE	"@02348" + CR
Fast Reverse Start <<	"@02350" + CR

continues



**Table of Control command codes continued**

Fast Reverse Stop <<	“@0235001” + CR
Fast Forward Start >>	“@02352” + CR
Fast Forward Stop >>	“@0235201” + CR
PLAY	“@02353” + CR
STOP	“@02354” + CR
RECORD	“@02355” + CR
A-B	“@02359” + CR
REC UNDO	“@023RU” + CR
Manual Track	“@023MT” + CR
Next EDL mark	“@023M+” + CR
Previous EDL mark	“@023M-” + CR
MARGIN RESET	“@023MR” + CR
Preset 1*	“@0PS01” + CR
Preset 2*	“@0PS02” + CR
Preset 3*	“@0PS03” + CR
Input Select*	
Unbalanced Input	“@0INUB” + CR
Balanced Input	“@0INBA” + CR
Digital In	“@0INDI” + CR
Date Form*	
M/D/Y	“@0DFDM” + CR
D/M/Y	“@0DFMD” + CR
Recording File Format*	
Channels	
Stereo	“@0CHST” + CR
Mono	“@0CHMO” + CR
Audio Format	
PCM	“@0AFPM” + CR
MP2	“@0AFM2” + CR
MP3	“@0AFM3” + CR
Bit Rate (XXX)**	“@0BRXXX” + CR
Sampling Rate (XX)**	“@0FSXX” + CR
File Format	
bwf	“@0FTBW” + CR
wav	“@0FTWA” + CR
mpg	“@0FTMG” + CR
mp3	“@0FTM3” + CR
BWF File Extension	
bwf	“@0EXBW” + CR
wav	“@0EXWA” + CR
PreRecord*	
ON	“@0PR00” + CR
OFF	“@0PR01” + CR
Auto Mark*	
ON	“@0AM00” + CR
OFF	“@0AM01” + CR
ManualTR*	
ON	“@0MT00” + CR
OFF	“@0MT01” + CR
AutoTrk*	
ON	“@0AK00” + CR
OFF	“@0AK01” + CR
Time	
hhmm	“@0ATHhmm” + CR
SeamlsPly*	
ON	“@0CP00” + CR
OFF	“@0CP01” + CR
SilentSkp*	
ON	“@0SS00” + CR
OFF	“@0SS01” + CR
seconds (XX)	“@0SCXX” + CR
M. Level (XX)	“@0SLXX” + CR
Auto Cue*	
ON	“@0AC00” + CR
OFF	“@0AC01” + CR
seconds (XX)	“@0CTXX” + CR

M.Level (XX)	“@0CLXX” + CR
Play Mode*	
Normal	“@0PMOF” + CR
Repeat All	“@0PMAL” + CR
Repeat TRK	“@0PMAR” + CR
Single	“@0PMSP” + CR
EDL Play*	
ON	“@0EP00” + CR
OFF	“@0EP01” + CR
Remote*	
StartPause	“@0RCSR” + CR
StrtPausTR	“@0RCSS” + CR
EDL Mark	“@0RCMA” + CR
Manual TRK	“@0RCMT” + CR
ID1Dscript*	“@0D1XXXXXX” + CR
ID2Origin	“@0D2XXXXXX” + CR
ID3OrRef	“@0D3XXXXXX” + CR
Default*	“@0DEFL” + CR

\*Must be in stop mode.  
\*\*Shorten. For example, 22.05KHz = 22.

## Table of Status Request and Status Information codes:

When a Status Request Command from the host is received by the PMD570, the PMD570 sends the Status Information to the host. When the PMD570 changes status, the PMD570 automatically sends Status Information to the host.

Status	Request Code	Information Code
Power Mode	"@0?PW" + CR	
On		"@0PW00" + CR
Off		—
Standby		"@0PW01" + CR
Door Condition	"@0?DS" + CR	
Open		"@0DS01" + CR
Closed		"@0DS00" + CR
Card Condition	"@0?CD" + CR	
No Card		"@0CDNC" + CR
Reading		"@0CDRE" + CR
Card Inside		"@0CDCI" + CR
Card Error		"@0CDCCE" + CR
Card 999		"@0CD99" + CR
Card Full		"@0CDFL" + CR
Blank Card		"@0CDBC" + CR
Read Error		"@0STER" + CR
Writing		"@0STWR" + CR
Write Error		"@0STEW" + CR
Operation Status	"@0?ST" + CR	
In Record		
Digital In Unlock		"@0STRU" + CR
Recording		"@0STRE" + CR
Rec Pause		"@0STRP" + CR
In Stop		
Stop		"@0STST" + CR
Track Select		"@0STTS" + CR
In Playback		
Play		"@0STPL" + CR
Play Pause		"@0STPP" + CR
Seek +		"@0STS+" + CR
Seek -		"@0STS-" + CR
Fast Forward		"@0STFF" + CR
Fast Reverse		"@0STRW" + CR
A-B Repeat		"@0STAB" + CR
EDL Play		"@0STEP" + CR
EDL A-B Repeat		"@0STEA" + CR
Others		
Track Edit /Preset		"@0STED" + CR
Operation Error		"@0STER" + CR
Display Condition	"@0?TMOD" + CR	
Rec Remain Time		"@0TMRE" + CR
Total Track Number		"@0TMTN" + CR
Total Mark Number		"@0TMTM" + CR
File Format		"@0TMAG" + CR
Date		"@0TMND" + CR
Track Time		"@0TMTT" + CR
Recorded Data		"@0TMRD" + CR
Track Remain Time		"@0TMTR" + CR
Track Number (XXX)	"@0?PS" + CR	"@0TRXXX" + CR
Track Time (hh:mm:ss)	"@0?TI" + CR	"@0TIhhmmss" + CR
Preset Number	"@0?PS" + CR	
Preset 1		"@0PS01" + CR
Preset 2		"@0PS02" + CR
Preset 3		"@0PS03" + CR
Input Selection	"@0?IN" + CR	
Unbalanced		"@0INUN" + CR

Balanced	"@0INBA" + CR
Digital In	"@0INDI" + CR
Date Form	"@0?DF" + CR
M/D/Y	"@0DFDM" + CR
D/M/Y	"@0DFMD" + CR
RecFormat	
Channels	"@0?CH" + CR
Stereo	"@0CHST" + CR
Mono	"@0CHMO" + CR
Audio Format	"@0?AF" + CR
PCM	"@0AFPM" + CR
MP2	"@0AFM2" + CR
MP3	"@0AFM3" + CR
Bit Rate (XXX)	"@0?BR" + CR
Sampling Rate (XX)	"@0?FS" + CR
File Format	"@0?FT" + CR
BWF	"@0FSBW" + CR
Wave	"@0FTWA" + CR
MP2	"@0FTMG" + CR
MP3	"@0FTM3" + CR
File Extension	"@0?EX" + CR
.bwf	"@0EXBW" + CR
.wav	"@0EXWA" + CR
.mpg	"@0EXM2" + CR
.mp3	"@0EXM3" + CR
Pre-record	"@0?PR" + CR
ON	"@0PR00" + CR
OFF	"@0PR01" + CR
Auto Mark	"@0?AM" + CR
ON	"@0AM00" + CR
OFF	"@0AM01" + CR
Manual TR	"@0?MT" + CR
ON	"@0MT00" + CR
OFF	"@0MT01" + CR
Auto Trk	"@0?AK" + CR
ON	"@0AK00" + CR
OFF	"@0AK01" + CR
Time (hhmm)	"@0?AT" + CR
SeamlsPly	"@0?CP" + CR
ON	"@0CP00" + CR
OFF	"@0CP01" + CR
SilentSkp	"@0?SS" + CR
ON	"@0SS00" + CR
OFF	"@0SS01" + CR
seconds (XX)	"@0?SC" + C
M.Level (XX)	"@0?SL" + CR
Auto Cue	"@0?AC" + CR
ON	"@0AC00" + CR
OFF	"@0AC01" + CR
seconds (XX)	"@0?CT" + CR
M.Level (XX)	"@0?CL" + CR
Play Mode	"@0?PM" + CR
Normal	"@0PMOF" + CR
Repeat All	"@0PMAL" + CR
Repeat TRK	"@0PMAR" + CR
Single	"@0PMSP" + CR
EDL Play	"@0?EP" + CR
ON	"@0EP00" + CR
OFF	"@0EP01" + CR
Remote	"@0?RC" + CR
StartPause	"@0RCSS" + CR
StrtPausTR	"@0RCSTR" + CR
EDLMark	"@0RCMA" + CR
Manual TRK	"@0RCMT" + CR
ID1Dscript	"@0?D1" + CR
ID2Origin	"@0?D2" + CR
ID3OrRef	"@0?D3" + CR

## Recording time chart

### Recording time chart

The recording time available on a CF card depends on the size of the card in MB, the recording type (.mp3, .mp2 or PCM), the bitrate of the recording and if recording in mono or stereo.

This Recording time chart lists approximate recording times based on those factors.

CARD SIZE	32 kbps		64 kbps		80 kbps		128 kbps		160 kbps		256 kbps		320 kbps	
	mono	stereo	mono	stereo	mono	stereo	mono	stereo	mono	stereo	mono	stereo	mono	stereo
<b>.mp3</b>														
32 MB	2:13:00	1:06:30	1:46:24	0:53:12	1:06:30	0:33:15	0:33:15	0:33:15	0:53:12	0:26:36	0:33:15	0:16:38	0:26:36	0:13:18
64 MB	4:26:00	2:13:00	3:32:48	1:46:24	2:13:00	1:06:30	1:06:30	1:06:30	1:46:24	0:53:12	1:06:30	0:33:15	0:53:12	0:26:36
128 MB	8:52:00	4:26:00	7:05:36	3:32:48	4:26:00	2:13:00	2:13:00	2:13:00	3:32:48	1:46:24	2:13:00	1:06:30	1:46:24	0:53:12
256 MB	17:44:00	8:52:00	14:11:12	7:05:36	8:52:00	4:26:00	4:26:00	4:26:00	7:05:36	3:32:48	4:26:00	2:13:00	3:32:48	1:46:24
340 MB	23:33:08	11:46:34	18:50:30	9:25:15	11:46:34	5:53:17	5:53:17	5:53:17	9:25:15	4:42:38	5:53:17	2:56:38	4:42:38	2:21:19
512 MB	35:28:00	17:44:00	28:22:24	14:11:12	17:44:00	8:52:00	8:52:00	8:52:00	14:11:12	7:05:36	8:52:00	4:26:00	7:05:36	3:32:48
(1 GB) 1024 MB	70:56:00	35:28:00	56:44:48	28:22:24	35:28:00	17:44:00	17:44:00	17:44:00	28:22:24	14:11:12	17:44:00	8:52:00	14:11:12	7:05:36
(2GB) 2048MB	141:52:00	70:56:00	113:29:36	56:44:48	70:56:00	35:28:00	35:28:00	35:28:00	56:44:48	28:22:24	35:28:00	17:44:00	28:22:24	14:11:12
(4GB) 4096MB	283:44:00	141:52:00	226:59:12	113:29:36	141:52:00	70:56:00	70:56:00	70:56:00	113:29:36	56:44:48	70:56:00	35:28:00	56:44:48	28:22:24

CARD SIZE	32 kbps		48 kbps		96 kbps		128 kbps		192 kbps		256 kbps		384 kbps	
	mono	stereo	mono	stereo	mono	stereo	mono	stereo	mono	stereo	mono	stereo	mono	stereo
<b>.mp2</b>														
32 MB	2:13:00	1:06:30	1:39:45	0:49:53	0:49:53	0:33:15	0:33:15	0:33:15	0:49:53	0:24:56	0:33:15	0:16:38	0:24:56	0:12:28
64 MB	4:26:00	2:13:00	3:19:30	1:39:45	1:39:45	1:06:30	1:06:30	1:06:30	1:39:45	0:49:53	1:06:30	0:33:15	0:49:53	0:24:56
128 MB	8:52:00	4:26:00	6:39:00	3:19:30	3:19:30	2:13:00	2:13:00	2:13:00	3:19:45	1:39:45	2:13:00	1:06:30	1:39:45	0:49:53
256 MB	17:44:00	8:52:00	13:18:00	6:39:00	6:39:00	4:26:00	4:26:00	4:26:00	6:39:00	3:19:30	4:26:00	2:13:00	3:19:30	1:39:45
340 MB	23:33:08	11:46:34	17:39:51	8:49:55	8:49:55	5:53:17	5:53:17	5:53:17	8:49:55	4:24:58	5:53:17	2:56:38	4:24:58	2:12:29
512 MB	35:28:00	17:44:00	26:36:00	13:18:00	13:18:00	8:52:00	8:52:00	8:52:00	13:18:00	6:39:00	8:52:00	4:26:00	6:39:00	3:19:30
(1 GB) 1024 MB	70:56:00	35:28:00	53:12:00	26:36:00	26:36:00	17:44:00	17:44:00	17:44:00	26:36:00	13:18:00	17:44:00	8:52:00	13:18:00	6:39:00
(2GB) 2048MB	141:52:00	70:56:00	106:24:00	53:12:00	53:12:00	35:28:00	35:28:00	35:28:00	53:12:00	26:36:00	35:28:00	17:44:00	26:36:00	13:18:00
(4GB) 4096MB	283:44:00	141:52:00	212:48:00	106:24:00	106:24:00	70:56:00	70:56:00	70:56:00	106:24:00	53:12:00	70:56:00	35:28:00	53:12:00	26:36:00

CARD SIZE	16 kHz		22.050kHz		24kHz		32kHz		44.1 kHz		48 kHz	
	mono	stereo	mono	stereo	mono	stereo	mono	stereo	mono	stereo	mono	stereo
<b>PCM</b>												
32 MB	0:16:40	0:08:20	0:12:06	0:06:03	0:11:07	0:05:33	0:08:20	0:04:10	0:06:03	0:03:01	0:05:33	0:02:47
64 MB	0:33:20	0:16:40	0:24:11	0:12:06	0:22:13	0:11:07	0:16:40	0:08:20	0:12:06	0:06:03	0:11:07	0:05:33
128 MB	1:06:40	0:33:20	0:48:23	0:24:11	0:44:27	0:22:13	0:33:20	0:16:40	0:24:11	0:12:06	0:22:13	0:11:07
256 MB	2:13:20	1:06:40	1:36:45	0:48:23	1:28:54	0:44:27	1:06:40	0:33:20	0:48:23	0:24:11	0:44:27	0:22:13
340 MB	2:57:05	1:28:33	2:08:30	1:04:15	1:58:04	0:59:02	1:28:33	0:44:16	1:04:15	0:32:07	0:59:02	0:29:31
512 MB	4:26:40	2:13:20	6:27:01	1:36:45	5:55:34	2:13:20	2:13:20	1:06:40	1:36:45	0:48:23	1:28:54	0:44:27
(1 GB) 1024 MB	8:53:21	4:26:41	6:27:01	3:13:30	5:55:34	2:57:47	2:13:20	1:06:40	3:13:30	1:36:45	2:57:47	1:28:54
(2GB) 2048MB	17:46:42	8:53:21	12:54:01	6:27:01	11:51:08	5:55:34	4:26:41	1:06:40	6:27:01	3:13:30	5:55:34	2:57:47
(4GB) 4096MB	35:33:24	17:48:42	25:48:04	12:54:01	23:42:16	11:51:06	8:53:21	4:26:41	12:54:01	6:27:01	11:51:08	5:55:34

These figures are an average of 4 cards of various sizes and manufacturers.

All times are approximated record times for the PMD570/PMID670.

Different media manufacturers allow more or less space for error correction and such on their respective products.

ALL TIMES ARE APPROXIMATE

## Troubleshooting

Should faults occur, it is in many cases not necessary to consult your dealer or technical service department. On the basis of the following checks, you will be able to rectify a number of conditions yourself without difficulty. If the condition cannot be remedied after the following check, please consult your dealer or contact Marantz Professional at 630 741 0330.

The PMD570 does not turn on

Check power cord and your home circuit breaker

The PMD570 seems to record but there is no sound on playback

- check input settings (For example, if Bal.In input is selected and no input is connected to the BAL-ANCED IN jacks the PMD570 will record silence.)
- is the amp on? Check to see if the correct input has been selected.

The PMD570 will not playback

- check EDL Play Menu setting, if ON switch to OFF

No audio playback through headphones

- check HEADPHONE-LEVEL control setting
- check a different track or CF card

The PMD570 will not record

- check that the maximum of 999 tracks have not been recorded
- make sure that you have not filled up the CF card with recordings based on time
- check that the PMD570 acknowledges the CF card

Excessive noise

- check cable connections and/or replace cables
- check for proper gain levels

Playback on a PC results in poor sound

- check quality of PC sound card and program
- check frequency conversion program\*
- be sure the PMD570 is set to the desired bitrate

\*The PMD570 can record audio files with a sampling frequency of 48kHz. Some PC programs convert the files to 44.1kHz (using a sample rate converter). Only high quality sample rate converters should be used.

PC cannot read files

- check if the files are MP2 or MP2 with a .wav file extension Some PC's cannot interpret this combination. Try renaming the MP2 file so it has a .mpg file extension.
- check the capability of the PC program Some playback and editing programs do not support MP2/MP3 or Broadcast Wave (.bwf/.wav) formats. Consult the Marantz Professional website at [www.d-mpro.com](http://www.d-mpro.com) for links to programs that support MP2/MP3 and Broadcast Wave Format.

Erratic behavior

- If the PMD570 exhibits erratic behavior, the microprocessor can be reset by, powering off and disconnecting AC power.

## Care and Maintenance

Clean case with a slightly moistened soft cloth.

Media cards that are heavily used should be occasionally reformatted to avoid audio problems due to fragmentation.

## Error Messages

Display	Description
<b>CF Card</b>	
NO_CARD	No CF card inserted, or card is not detected.
UNFORMAT	Initializing of CF card is failure or track information renewal failure
FULL_CARD	Remaining capacity of CF card is less than a few Kbytes.
You Need FormatOnPC	CF card is not formatted.
Format Fail	Formatting failure
NO_FILE	Correct file does not exist.
FULL_999	The number of tracks on the CF card has reached the 999 maximum.
Can not...	Wave format error was detected during PCM file playback.
Mark_255	The number of EDL marks on the card has reached the 255 maximum.
No_Good	Accessing speed of the CF card is not suitable.
<b>Others</b>	
UnLock	A corrupt digital audio signal was received during recording with digital input.
NO_EDL EDLERROR-A	A or B point for EDL A-B loop was not found.
DSP ERROR	DSP processing error

## Specifications<sup>1</sup>

### Digital audio system

System ..... Solid State Recorder  
Usable Media ..... CF memory cards  
(Microdrive) cards

#### Recording and media methods

.mp2 ..... MPEG1 Layer II compression  
.mp3 ..... MPEG1 Layer III compression  
.mp3 ..... MPEG2 Layer III compression\*  
\*for all half sample rates.  
PCM ..... 16 bit linear PCM

#### Recording bit rate (selectable)

MP2 mono ..... 192, 128, 96, 64, 48, 32 kbps  
MP2 stereo ..... 384, 256, 192, 128, 96, 64 kbps  
MP3 mono ..... 160, 128, 80, 64, 40, 32 kbps  
MP3 stereo ..... 320, 256, 160, 128, 80, 64 kbps

#### Sampling frequency

Analog ..... 48, 44.1, 32, 24\*, 22.05\*, 16\* kHz  
\*except MP2  
Digital ..... 48, 44.1 kHz

Number of channels ..... 2 (stereo), 1 (mono)

### Audio

Frequency response ..... 20,000 Hz (-0.5dB)  
Signal-to-Noise Ratio  
IEC-A weighted ..... 91 dB  
Total Harmonic Distortion  
at 0 VU (PCM) ..... 0.01%  
Dynamic Range ..... 94 dB

### Inputs

#### BALANCED IN L/R

Type ..... XLR (1:GND, 2:HOT, 3:COLD)  
Input Sensitivity ..... +16dBu/@0dBFS  
(+4dBu/@-12dBFS) /24 kohms  
Trim Control ..... 0 to 24dB

#### LINE IN L/R

Type ..... RCA jack  
Input Sensitivity ..... 500 mVrms/22 kohms

#### DIGITAL IN

Type ..... RCA jack  
Input impedance ..... 75 ohms  
Standard input level ..... 0.5 Vp-p  
Sampling frequency ..... 44.1/48 kHz  
Format ..... SPDIF (IEC 958 TypeII)

### Outputs

#### LINE OUT L/R

Type ..... RCA jack  
Standard level ..... 2 Vrms max./300 ohms

#### DIGITAL OUT

Type ..... RCA jack  
Output impedance ..... 75 ohms  
Standard output level ..... 0.5 Vp-p  
Sampling frequency ..... 44.1/48 kHz  
Format ..... SPDIF (IEC-958 Type II)

### General

#### Power requirements

US model ..... AC120V 60Hz  
European model ..... AC230V 50Hz

Power consumption ..... 5.3W

Headphone Output power ..... 20 mW/32 ohms

#### Dimensions

Width ..... 483 mm  
Height ..... 52 mm  
Depth ..... 298 mm  
Weight ..... 3.0 kg

#### Included accessories

CF card\* (64MB) ..... 1  
Power cord ..... 1  
I/O cable ..... 1  
Stereo audio cables ..... 2  
Screw (ISO 3x10 mm) ..... 2  
Plastic pin and retainer ..... 1  
User Guide ..... 1

\*A CF card (Compact Flash™ memory card) or a Microdrive™ is needed for the PMD570 to work. Also used in digital cameras, removable flash memory media, widely available at consumer electronics retailers and computer resellers, come in a variety of sizes and connection configurations. The PMD570 accepts "Compact Flash" and "Microdrive" media.

The recording time depends on the size of the CF card and the recording parameters. See chart on page 51.

#### Optional Accessories

(See [www.d-mpro.com](http://www.d-mpro.com) for descriptions and/or ordering information.)

##### Remote control

Model RC600 ..... wired remote  
start recording, pause recording,  
add EDL marks

<sup>1</sup>Specifications subject to change without notice.

## Limited Warranty

Your Marantz Professional product is warranted against manufacturer defects in material and workmanship for a period of two years parts and labor.

Except as specified below, this warranty covers defects in material and workmanship. The following are not covered under warranty:

1. Damage, deterioration, malfunction or failure to meet performance specifications resulting from:
  - a) Accidents, acts of nature, misuse, abuse, neglect or unauthorized product modification.
  - b) Improper installation, removal or maintenance, or failure to follow supplied instructions.
  - c) Repair or attempted repair by a non-Marantz authorized agent.
  - d) Any shipment (claims must be presented to the carrier).
  - e) Any cause other than a defect of manufacturing.
2. Cleaning, check-ups with no fault found or changes incurred for installation, removal or reinstallation of the product.
3. Any serialized product on which the serial number has been defaced, modified or removed.
4. Batteries and battery chargers.
5. Accessories, including but not limited to: cables, mounting hardware and brackets, cleaning accessories, power cords and adapters, and carry cases.
6. Products purchased outside of the United States, its possessions or territories.

### Non-transferable warranty

This Warranty may be enforced only by the original purchaser.

### What We Will Pay For

We will pay for all labor and material expenses for items covered by the warranty.

### How You Can Get Service

1. If your unit needs service in the USA, contact our service referral at the appropriate telephone number indicated below.

We will advise you of the name and location of one or more authorized service centers from which service may be obtained. Please do not return the unit directly to us.

2. You must pay any shipping charges if it is necessary to ship the product for service. If the necessary repairs are covered by the warranty, we will pay return shipping charges to your location anywhere in the United States or its territories.
3. Whenever warranty service is required, you must present the original dated sales receipt or other proof of date purchased.

### Limitation of Implied Warranties

All implied warranties, including warranties of merchantability and fitness for a particular purpose, are limited in duration to the length of this warranty.

### Exclusion of Damages

Liability for any defective product is limited to repair or replacement of the product at manufacturer's option. Manufacturer shall not be liable for damage to other products caused by any defects in Marantz products, damages based on inconvenience or loss of use of the product, or any other damages, whether incidental, consequential, or otherwise.

Some States do not allow limitations on how long an implied warranty lasts and/or do not allow the exclusion or limitation of incidental or consequential damages, so the above limitations and exclusions may not apply to you.

### How State Law Relates to the Warranty

This warranty gives you specific legal rights, and you may have other rights which may vary from State to State.

### Marantz Professional Service Number:

Marantz Professional Factory Service (630) 741-0330

This warranty is enforceable only in the United States and its possessions or territories.



**marantz®**

Marantz is a registered trademark.

